

INFLUENCE OF MOISTURE ON THE PHYSICAL PROPERTIES AND PARAMETERS OF THE COMPRESSION PROCESS OF LEGUMES' SEEDS

J. Laskowski, S. Skonecki

University of Agriculture, Department of Machine Operation in Food Industry, Doświadczalna 44
20-236 Lublin, Poland

Accepted September 10, 1997

A b s t r a c t. Results of the studies on the influence of moisture on the physical properties, and parameters of the pressure compression process of legumes' seeds are presented. The studies covered some chosen varieties of ground legume seeds: horse bean, bean, lupine, and vetch with differentiated moisture levels. Quantitative coefficients of the material ability for compression were determined. The coefficients can be utilised for the classification of raw materials and fodder mixes in respect of their abilities for granulation.

K e y w o r d s: biological material, physical properties, compression, granulability

INTRODUCTION

During the process of granulation raw materials and mixes for fodder are subjected to forces that change the state of their compression. The course of density changes, alongside the influence exerted by the construction parameters of the press, depends on the physical and chemical characteristics of the mixture. Hence, various components of fodder mixes exhibit a certain ability for compression that is characteristic of a given component, and is its natural property [4].

Data from literature show that only few authors studied susceptibility to agglomeration of various fodder components. Among the research work carried out up till now, David and Lefumeux [1] attempted to evaluate susceptibility for granulation. An interesting characteristic

was worked out by Mac Mahon and Payne [11], who determined: granule quality coefficient (0-10); abrading activity (0-10); maximum contribution of a given component in the fodder mix (in %), and the content of protein, fat, and cellulose in each of the studied product. Another method of qualification of raw materials was proposed by Tylzanowski [12], who evaluated several components using the scale from zero to five. Attempts to determine susceptibility to compression for other materials are presented in works [2,3].

The above literature survey allows us to state that there are no uniform definitions of the term "pelleting ability" for the fodder raw materials and mixes.

On the basis of many year's research, a method of analysing the granulation mechanism [4-8,10] has been worked out, and a coefficient of material susceptibility to granulation has been determined. Unlike the methods of determining susceptibility for granulation mentioned above, the present study assumed that granulation susceptibility can be described as the value of the change in density under a certain pressure of compression, and the values of the energy expenditure (unit of work during pressing) related to the increase in the density of the material.

In the present work the results of studies on determination of moisture influence on the parameters of the pressure compression process, and on the indices of material susceptibility to granulation in some chosen legumes' material were presented. In order to characterise raw materials, the influence of moisture on the basic physical parameters was studied.

MATERIALS AND METHODS

Crushed kernels of horse bean (variety Nadwiślanska), bean (variety Fidelia), lupine (var. Emir), and vetch (var. Szelejewska) were studied.

Raw materials were crushed in an universal mill type Bak H 111/3 with sieves with 3 mm mesh. An average particle size (determined according to the standard PN-89/R-64798 - the mesh used was 2.0, 1.6, 1.2, 1.0, 0.8, 0.5, 0.4, 0.315, 0.256 mm) of the raw material at the moisture level of 14% was as follows: horse bean - 0.86 mm, bean - 0.892 mm, lupine - 1.087 mm, and vetch - 0.844 mm.

The studies on the physical properties and the properties of the compression process were carried out for the materials with differentiated moisture levels ranging from 10% to 18% (every 2%).

Studies on the physical properties of raw materials included:

- density in the bulk state (ρ_n),
- density in the shaken up state (ρ_u),
- angle of repose (γ_u),
- angle of slide (γ_z).

All the determinations were carried out according to the valid regulations.

Moreover, the value of the coefficient of internal friction (μ_b) was also determined. The measurements were performed on the apparatus for direct shearing (type AB-2a). A sample of the material was placed in the trial cell which was a bipartite box consisting of two metal frames with the size of 6 x 6 cm each. The trial compartment was filled up to the 2/3 of the upper frame high. A perforated metal plate was put in. On the plate there was a piston was subjected to a normal force obtained from the

correct mechanism of the apparatus, and recorded on the vertical dynamometer. The shearing force was activated by moving the upper frame. The value of this force was recorded up the moment of material cut off. A ring stop with an extensometer was used. Its deformations were entered into the computer programme through the extensometric bridge, and the value of the shearing force could be read. The studies were carried out at five values of the normal loading force, i.e., 1.0, 1.5, 2.0, 2.5, and 3.0 kN. A mean value from three determinations was taken as a coefficient of internal friction.

Studies on the compression process of the material samples were carried out on a hydraulic press type ZD 40 according to the methods by the present authors [7,8].

A measuring set with a computer recording of the compressing force value and material deformation, adjusted to cooperate with the ZD-40 press was presented in Fig. 1 [9].

An extensometric transducer (5) was used to measure the compressing force. Four extensometric stoppers were stuck onto the steel ring; two of them in the inside of the ring, and two on its outside, along the axe perpendicular to the direction of the force impact. The extensometers were coupled with each other to form the so-called full bridge system, and were then connected to the extensometric amplifier (7), and the computer (10) through an analogue-digital transducer (9).

The size of deformation is recorded by means of a transducer of linear transitions type P_{sx} (6) coupled with the computer (10) through an apparatus with the MPL carrying wave (8) and an analogue-digital transducer (9).

A specialist computer programme enabled data recording and analyses. The programme consists of two parts. The first one is for direct data collection (values of forces and transitions) during the experimental period, and data recording on a disk; whereas the other part is for data analysis. The programme for studying agglomeration processes enables a detailed analysis of the characteristics obtained, i.e., determination of the process parameters (force

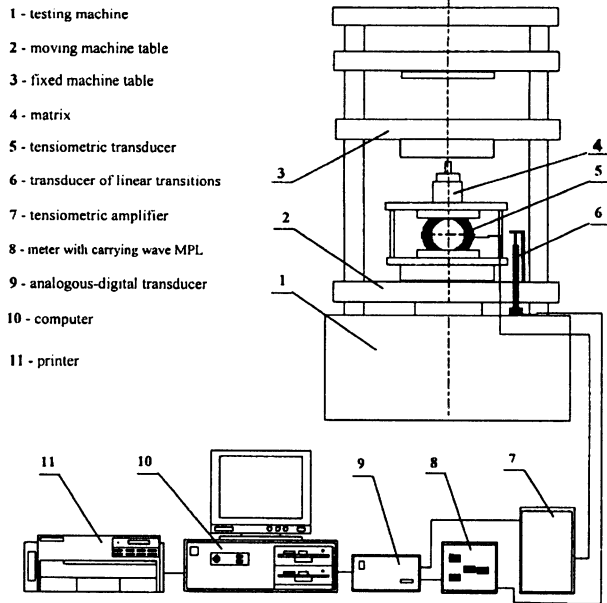

Fig. 1. Layout of the ZD-40 press and the measuring system with a computer recording of the compressing force and material deformation [9].

value, material density, energy expenditure, etc.) [9].

A densifying set was used for the present study (Fig. 2). It contained a closed matrix (an inner diameter of the cylinder equal to 25 mm).

Material samples of 20 g each were subjected to compression. The maximum densifying force was $F_m = 100$ kN, and the piston speed $v=0.3$ mm/s. During the experiment, a compression curve was observed (Fig. 3). A detailed description of the compression characteristics was presented in [7,8].

On the basis of the pressing process run it was proved that the following parameters of the process can be taken for the evaluation of the material susceptibility to granulation [7,8]:

- compression pressure (P_b),
- compression work (L_b) or the specific compression work (L_b') - Eq.(3),
- total compression work (L_c) that is a sum of the compression work (L_b) and compression work (L_m) or the total specific compression work (L_c') - Eq.(5).

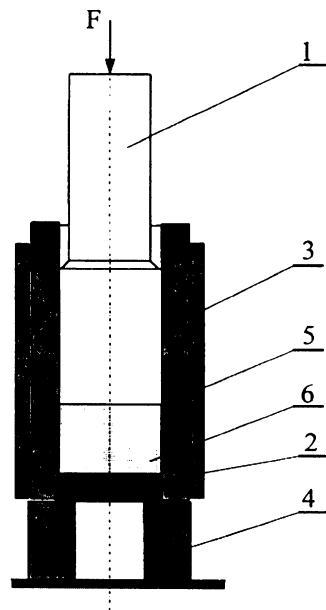

Fig. 2. Layout of the pressing assembly: 1 - piston, 2 - matrix, 3 - cylinder, 4 - base, 5 - heating element, 6 - material.

In the present study compression pressure and unit compression work were taken for the analyses.

The following coefficients characterising material susceptibility to granulation were also determined:

- a coefficient taking into consideration changes in the material density under pressure, the so-called coefficient of the material ability to densify (k_1) determined by the equation:

$$k_1 = \frac{\rho_b / \rho_n}{P_b} \quad (\text{MPa}^{-1}) \quad (1)$$

where ρ_b - material density in the matrix determined for the B point of the pressing characteristics, (g/cm^3), ρ_n - initial density, (g/cm^3); P_b - compression pressure corresponding to the F_b force, (MPa);

- coefficient (k_2) determining the values of the specific compression work related to the increase in material density, calculated from the equation:

$$k_2 = \frac{L_b'}{\rho_b - \rho_n} \quad \left(\frac{\text{J}/\text{g}}{\text{g}/\text{cm}^3} \right) \quad (2)$$

where:

$$L_b' = L_b/m \quad (\text{J}/\text{g}) \quad (3)$$

m - weight of the densified material (g);

- coefficient (k_3) determining the values of total specific pressing work related to the density increase calculated from the equation:

$$k_3 = \frac{L_c'}{\rho_c - \rho_n} \quad \left(\frac{\text{J}/\text{g}}{\text{g}/\text{cm}^3} \right) \quad (4)$$

where ρ_c - material density in the matrix calculated for the point C of the characteristics, (g/cm^3);

$$L_c' = L_c/m \quad (\text{J}/\text{g}). \quad (5)$$

The tablets obtained in this way were then subjected to resistance tests in the axial compression trials carried out on an universal testing apparatus Instron type 4302. The maximum force destroying the briquette was

determined, and its resistance was calculated from the equation:

$$\sigma_n = \frac{F_N}{S_B} \quad (\text{MPa}) \quad (6)$$

where F_N - force destroying an agglomerate during axial compression (N); S_B - agglomerate cross-section, (m^2).

For the evaluation of the agglomerate obtained (a briquette) a coefficient describing its ability to preserve shape was determined; it was calculated from the equation:

$$k_4 = \frac{\sigma_n}{P_b} \quad (7)$$

where σ_n - agglomerate resistance to compression, calculated from the Eq. (6).

The values of the compression features enumerated above were determined for a given material and for a certain moisture level as a mean value of three repetitions.

The study results were then subjected to the statistical analysis. For each of the raw materials relations between the physical parameters, pressing parameters, and coefficients (k_1, k_2, k_3, k_4), as well as agglomerate resistance and moisture level of the material were determined. Using the Excel Spread Sheet regression relations and the values of the determination coefficient (R^2) were determined. The statistic analysis allowed for assuming linear relations or polynomials of the second degree. The study results were presented in tables in the form of the regression relations. Because of the similar course of changes of many of the studied features in relation to moisture only some chosen relations were presented on graphs.

RESULTS

Results of studies on the physical parameters of the raw materials

Relations between the density in the bulk state (ρ_n), and density in the shaken up state (ρ_u) on one hand, and raw material moisture level on the other were given in Table 1 in the form of

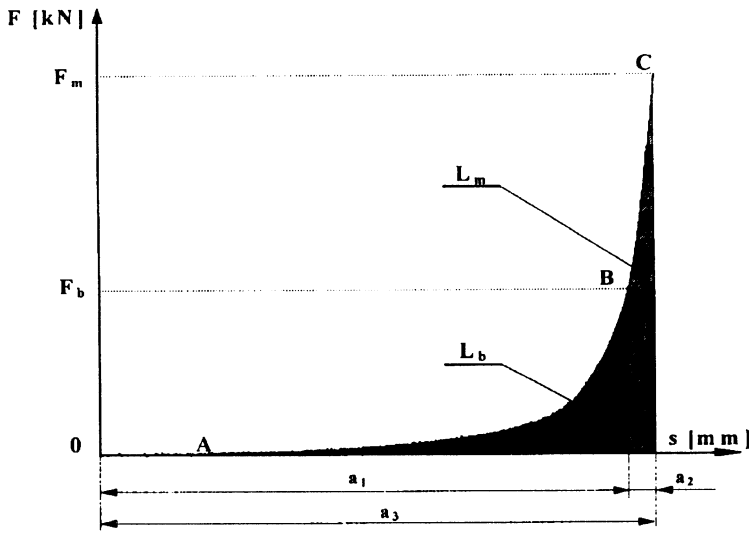

Fig. 3. Characteristics of compression: a₁ - the phase of plastic deformation, a₂ - the phase of elastic deformation, a₃ - pressing [7].

Table 1. Regression equations for the relation between density in the bulk state (ρ_n) and density in the shaken up state (ρ_u) on one hand, and material moisture (w), and values of the coefficient of determinations (R^2)

Density state	Material	R^2	Regression equation
1	2	3	4
bulk state	Horse bean	0.987	$\rho_n = -0.001w^2 + 0.018w + 0.7278$
	Bean	0.892	$\rho_n = -0.0027w^2 + 0.065w + 0.3735$
	Lupine	0.984	$\rho_n = -0.001w^2 + 0.0204w + 0.4767$
	Vetch	0.921	$\rho_n = -0.002w^2 + 0.0416w + 0.5492$
tapped state	Horse Bean	0.958	$\rho_u = -0.0021w^2 + 0.0437w + 0.6878$
	Bean	0.979	$\rho_u = -0.0013w^2 + 0.0177w + 0.8264$
	Lupine	0.956	$\rho_u = -0.0005w^2 + 0.0008w + 0.7408$
	Vetch	0.880	$\rho_u = -0.0004w^2 + 0.0287w + 1.0939$

regression equations together with the values of the determination coefficient R^2 .

As it follows from the analysis of the regression equations, changes in these density levels with the increase in the moisture level is similar for all the studied materials. Differences appear in individual values. In Fig. 4 some examples of the relations between the density ρ_n the range from 0.53 g/cm³ to 0.796 g/cm³ were presented. The density ρ_u values ranged from 0.562 g/cm³ to 0.919 g/cm³. The highest values of density were noted for horse bean, and the lowest for lupine. From the analysis of the results obtained, it can be concluded that density in the bulk state (ρ_n) and density in the shaken

up state (ρ_u) decrease with the increase in the material moisture content.

Relation between the angle of repose (γ_u) and angle of slide (γ_z) on one hand, and material moisture content on the other, was given in the form regression equations in Table 2.

The values of the angle of repose (γ_u) ranged from 36.2 deg. to 43.2 deg. The highest values were obtained for lupine, and the lowest for vetch. In the case of horse bean, bean, and lupine, with an increase of moisture content in the range from 10 to 16%, the value of the angle of repose (γ_u) increases, and in the range 16-18% it decreases. Whereas for lupine the values of the angle of repose increase with the increase of moisture content.

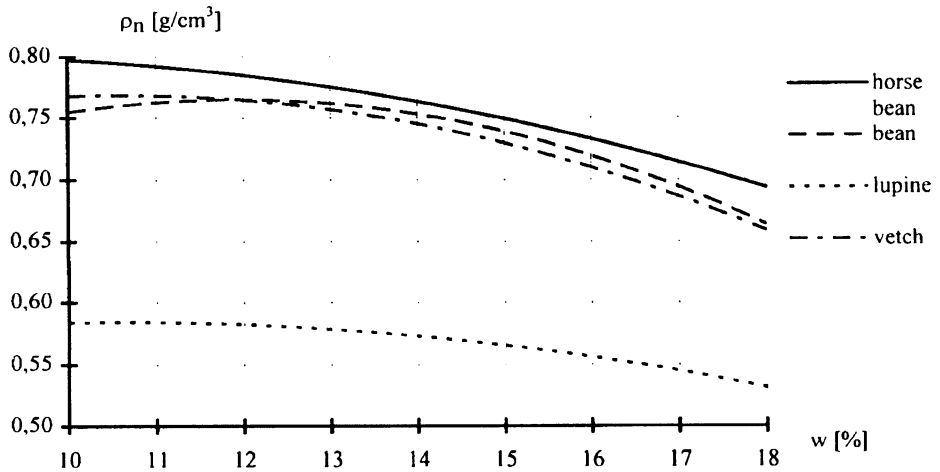

Fig. 4. Relation between the density in the bulk state (ρ_n) and material moisture level (w).

The values of the angle of slide (γ_z) ranged from 22.5 deg. to 26.5 deg.. The highest values were noted for vetch, and the lowest for lupine. In the case of horse bean, bean, and vetch the values of angle of slide (γ_z) increased in the moisture range from 10% to 16% and decreased in the range 16-18% along the increase in the moisture level. Whereas the values of angle of slide of lupine decreased with an increase of the moisture content in the range 10-12%, and increased in the range 12-18%.

Relation between the coefficient of internal friction (μ_b) and material moisture content was presented in Table 3 as an equation of regression.

The values of the coefficient of internal friction ranged from 0.43 to 0.97. The highest values were noted for horse bean, and the lowest for vetch. The coefficient of the internal friction of horse bean, bean, lupine was of higher values with an increase in the moisture content, and for the vetch it increased with the moisture increases in the range from 10 to 14%, and decreased in the range of 14-18% moisture.

Study results on the process of pressure compression

Relation between compression pressure for the point B (P_b) and material moisture content was presented in Fig. 5. Regression equations describing these relations and the values of the

determination coefficient R^2 were given in Table 4.

The highest values of the compression pressure were obtained for bean - from 144.97 MPa (for $w=10\%$) to 93.15 MPa (for $w=18\%$), and the lowest for lupine - from 117.31 MPa to 28.15 MPa (Fig. 5). The values of pressure for the remaining raw materials changed from 115 MPa to 62 MPa (in the material moisture range from 10 to 18%). As can be gathered from Table 4 and Fig. 5, compression pressure decreased linearly with the increase in the moisture content for all the studied materials.

Relations between specific energy expenditure for compression (L_b) and moisture was presented in Fig. 6. The regression equation that described these relations and the values of R^2 coefficient were given in Table 4.

The values of the specific work for compression ranged from 1.90 J/g to 12.85 J/g (Fig. 6). The highest expenditure of this work was obtained for bean, and the values were changing with the increase in moisture in the range from 12.85 J/g to 5.4 J/g. As it followed from Fig. 6, a specific work for compression decreased linearly with the increase of moisture. The highest decrease of this work was noted for lupine, i.e., from 11.2 J/g to 1.90 J/g.

Similarly to the unit work for compression, also total specific compression work (L_c) was

Table 2 Regression equations for the relation between the angle of repose (γ_u) and angle of slide (γ_z), and the moisture level of raw material, and the value of the determination coefficient (R^2)

Angle	Material	R^2	Regression equation
1	2	3	4
angle of repose	Horse bean	0.395	$\gamma_u = -0.1655w^2 + 4.837w + 6.44$
	Bean	0.484	$\gamma_u = -0.0536w^2 + 1.683w + 27.35$
	Lupine	0.789	$\gamma_u = -0.3054w^2 + 8.698w + 18.89$
	Vetch	0.504	$\gamma_u = -0.0036w^2 + 0.33w + 33.64$
angle of slide	Horse bean	0.517	$\gamma_z = 0.0356w^2 - 1.2w + 31.58$
	Bean	0.481	$\gamma_z = 0.655w^2 - 1.983w + 37.01$
	Lupine	0.699	$\gamma_z = 0.952w^2 - 2.4w + 36.24$
	Vetch	0.713	$\gamma_z = 0.0774w^2 - 2.65w + 44.58$

Table 3. Regression equations for the relation between the coefficient of internal friction (μ_b) and moisture level of raw material, and the values of the determination coefficients (R^2)

Parameter	Material	R^2	Regression equation
1	2	3	4
internal friction coefficient	Horse bean	0.965	$\mu_b = 0.0082w^2 - 0.191w + 1.732$
	Bean	0.648	$\mu_b = 0.0043w^2 - 0.092w + 1.179$
	Lupine	0.905	$\mu_b = -0.0021w^2 + 0.074w + 0.151$
	Vetch	0.998	$\mu_b = -0.0136w^2 + 0.411w + 2.323$

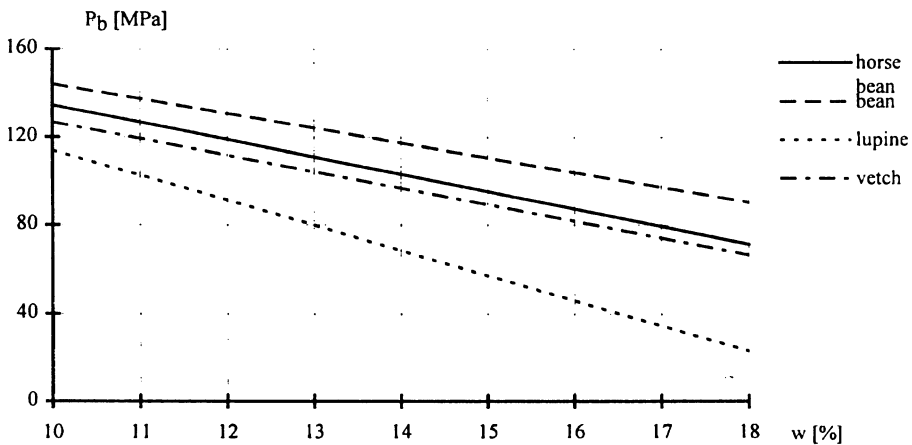

Fig. 5. Relation between the pressure of compression (P_b) and material moisture level (w).

changing (Table 4). The value of this work for the studied materials ranged from 17.4 J/g to about 9 J/g. Generally speaking, it can be said that specific works (L_b' and L_c') decreased in direct proportion to the increase in the moisture of the crushed legumes.

Studies on the material compression ability

Material compression ability was determined by means of the coefficients (k_1, k_2, k_3). The regression equations describing relations between these coefficients and

Table 4. Regression equations for the relations between compression pressure (P_b), specific works (L_b') and (L_c') on one hand, and material moisture content (w), and the values of the coefficients (R^2)

Parameter	Material	R^2	Regression equation
1	2	3	4
compression pressure	Horse bean	0.970	$P_b = -7.884w + 213.53$
	Bean	0.911	$P_b = -6.742w + 211.81$
	Lupine	0.983	$P_b = -11.346w + 227.46$
	Vetch	0.971	$P_b = -7.488w + 201.68$
specific works	Horse bean	0.961	$L_b' = -0.6717w + 16.82$
		0.952	$L_c' = -0.6842w + 20.86$
	Bean	0.919	$L_b' = -1.01w + 22.62$
		0.882	$L_c' = -1.1008w + 27.54$
	Lupine	0.957	$L_b' = -1.235w + 22.81$
		0.877	$L_c' = -0.7333w + 22.06$
	Vetch	0.976	$L_b' = -0.785w + 18.96$
		0.967	$L_c' = -0.9042w + 25.01$

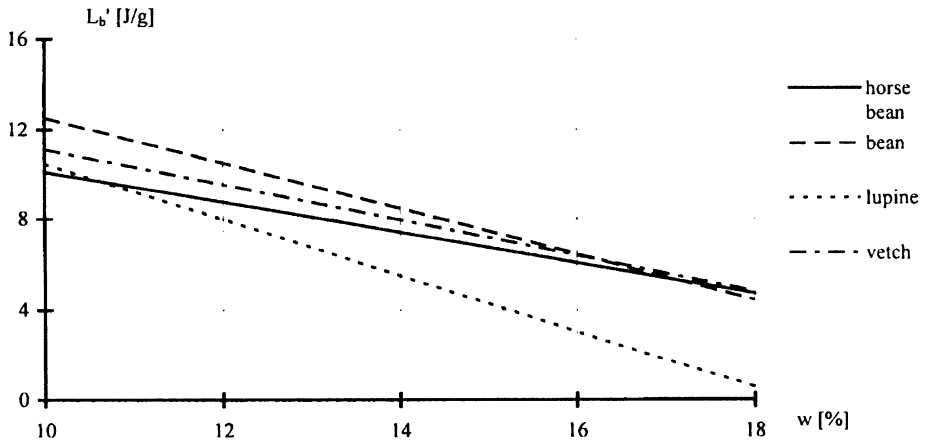

Fig. 6. Relation between the specific compression work (L_b') and material moisture level (w).

Table 5. Regression equations for the relation between the coefficients (k_1 , k_2 , k_3) and material moisture content (w), and the values of the coefficients of determinations (R^2)

Coefficient	Material	R^2	Regression equation
1	2	3	4
k_1	Horse bean	0.982	$k_1 = 0.0003w^2 - 0.0055w + 0.0431$
	Bean	0.955	$k_1 = 0.0008w^2 - 0.0007w + 0.0129$
	Lupine	0.985	$k_1 = 0.0011w^2 - 0.0231w + 0.1383$
	Vetch	0.970	$k_1 = 0.0003w^2 - 0.0065w + 0.0491$
k_2	Horse bean	0.980	$k_2 = 0.036w^2 - 2.0339w + 31.252$
	Bean	0.965	$k_2 = 0.1255w^2 - 5.0246w + 55.875$
	Lupine	0.996	$k_2 = 0.1196w^2 - 4.6472w + 47.437$
	Vetch	0.983	$k_2 = 0.0166w^2 - 0.7403w + 24.656$
k_3	Horse Bean	0.972	$k_3 = 0.0377w^2 - 2.0836w + 35.674$
	Bean	0.966	$k_3 = 0.1694w^2 - 6.3321w + 68.878$
	Lupine	0.985	$k_3 = 0.1129w^2 - 4.0072w + 44.249$
	Vetch	0.979	$k_3 = 0.007w^2 - 1.1157w + 32.439$

moisture or the coefficients of determination R^2 were given in Table 5.

Relations between the coefficient of material ability for compression (k_1) and its moisture was presented in Fig. 7. For the studied materials the above coefficient ranged from 0.013 MPa^{-1} to 0.094 MPa^{-1} . The coefficient's value increased with the increase in moisture content in the case of all the studied materials. The biggest changes and the highest values of the coefficient were obtained for lupine ($0.022 - 0.094 \text{ MPa}^{-1}$), and the lowest for bean ($0.013 - 0.024 \text{ MPa}^{-1}$).

Relation between the k_2 coefficient and material moisture content was presented in Fig. 8. The values of this coefficient range from $17.65 \frac{\text{J/g}}{\text{g/cm}^3}$ to $1.73 \frac{\text{J/g}}{\text{g/m}^3}$ (in the raw material moisture range from 10 to 18%). The highest values were noted for bean, and the lowest for lupine. It followed from the analysis that with an increase in the moisture, the value of the k_2 coefficient decreased in the case of all the studied materials. Its lowest values were noted for lupine, and higher or similar ones for the remaining materials.

Relations between the k_3 coefficient and moisture is of a similar form and course as the relation for the k_2 coefficient, which followed from the regression equation (Table 5). The k_3 coefficient is in direct proportion to the specific work of compression (Eq. (4)). The higher the value of specific work, the bigger the coefficient. Additionally, density in the bulk state and final density of the material influenced the coefficient during the process of compression.

The values of the coefficient for the studied materials ranged from $8.91 \frac{\text{J/g}}{\text{g/cm}^3}$ to 22.13

$\frac{\text{J/g}}{\text{g/cm}^3}$. The highest values of the coefficient

were noted for bean ($10.09 - 22.13 \frac{\text{J/g}}{\text{g/cm}^3}$) and

the lowest for lupine ($8.91 - 15.49 \frac{\text{J/g}}{\text{g/cm}^3}$).

It can be concluded on the basis of the results of the analysis that with an increase in the moisture content the values of the k_2 , k_3 coefficients decreased for all the studied varieties. The lowest values were obtained for lupine and the values for all the other studied materials are close.

Evaluation of the quality of agglomerates obtained

Quality of the agglomerates obtained was determined in respect to their resistance to compression (σ_n) and using the coefficient of shape preservation (k_p). The regression equations that describe relations between resistance to compression and coefficient of shape preservation on one hand, and material moisture content and the values of determination coefficient R^2 on the other, were given in Table 6.

Agglomerates' resistance increased with an increase in the moisture content up to 16%, whereas in the moisture range 16-18% resistance decreased. The highest agglomerate resistance to compression was noted for bean, and the lowest for lupine.

Relation between the coefficient of shape preservation and moisture is presented in Fig. 9. A significant influence on the coefficient of shape preservation was exerted by the compression pressure and agglomerate resistance to compression (pattern 7). On the basis of the study results it can be stated that the value of the shape preservation coefficient for a given material (Fig. 9) increased with the increase of moisture. The values of this coefficient ranged from 0.002 to 0.069. The highest values were observed for vetch (0.013 - 0.069), and the lowest for lupine (0.002 - 0.030).

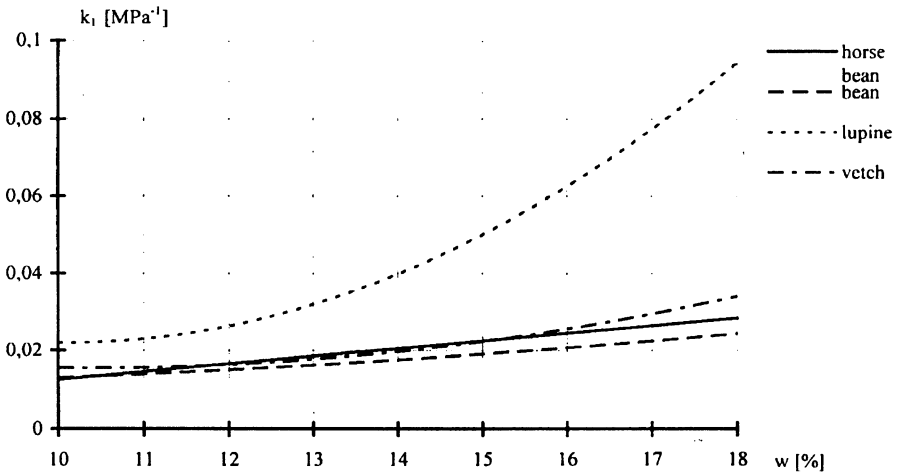

Fig. 7. Relation between the coefficient (k_1) and material moisture level (w).

Table 6. Regression equations for the relation between the agglomerate resistance (σ_n), coefficient (k_1) and material moisture content (w), and the values of the coefficients of determinations (R^2)

Parameter	Material	R^2	Regression equation
1	2	3	4
agglomerate resistance	Horse bean	0.887	$\sigma_n = -0.0457w^2 + 1.623w - 10.87$
	Bean	0.867	$\sigma_n = -0.0388w^2 + 1.674w - 12.02$
	Lupine	0.828	$\sigma_n = -0.0133w^2 + 0.459w - 3.04$
	Vetch	0.869	$\sigma_n = -0.0509w^2 + 1.853w - 12.28$
coefficient k_1	Horse bean	0.954	$k_1 = 0.0055w - 0.0492$
	Bean	0.892	$k_1 = 0.0068w - 0.0615$
	Lupine	0.916	$k_1 = 0.0039w - 0.0394$
	Vetch	0.955	$k_1 = 0.0076w - 0.0672$

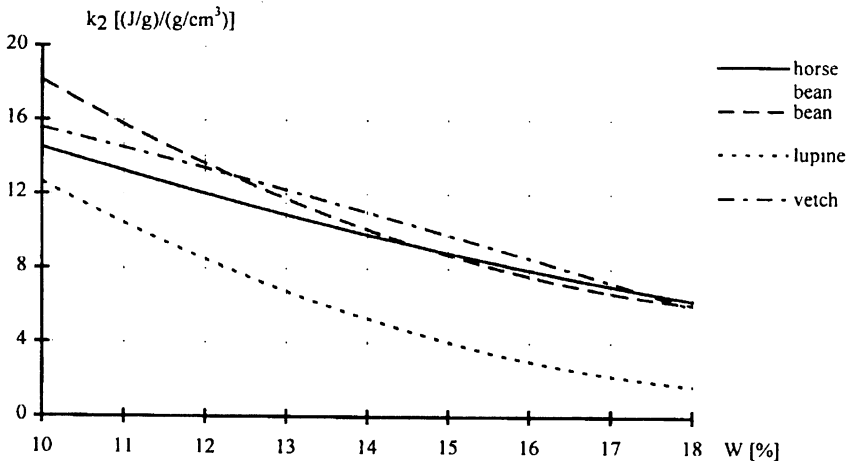

Fig. 8. Relation between the coefficient (k_2) and material moisture level (w).

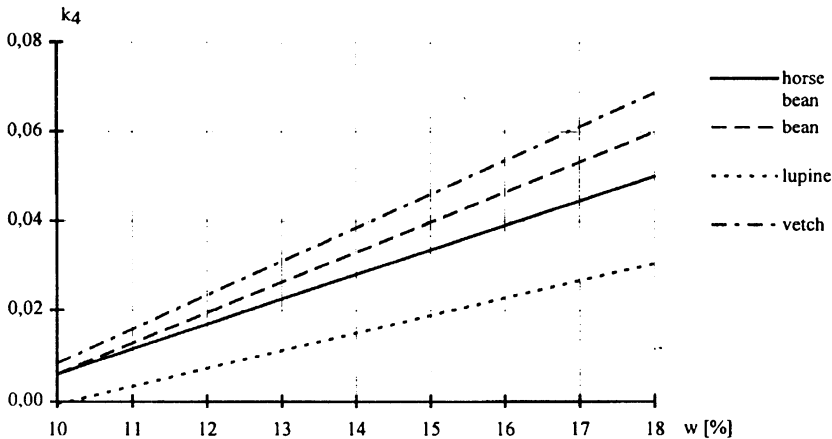

Fig. 9. Relation between the coefficient (k_4) and material moisture level (w).

CONCLUSIONS

The studies carried out on some chosen crushed legumes' seeds allow for drawing the following conclusions:

1. Moisture level of the material significantly influences physical parameters of this material, parameters of the compression process, and material compression ability, and the quality of agglomerate.

2. With an increase in the moisture level of the crushed seeds of horse bean, bean, lupine and vetch, the repose and shaken density decreases. The values of the angles of repose and slide, as well as the coefficient of internal friction do not show uniform tendencies towards either increasing or decreasing with the changes in moisture levels. The character of these changes is different for the different varieties studied.

3. An increase in the moisture level of the material results in a unique tendencies towards changes in the parameters of the compression process. Compression pressure as well as individual work expenditure of compression decrease proportionally with the increase in the material moisture level. The highest values of the compression parameters were obtained for bean, and the lowest for lupine.

4. The results of studies on the coefficients of the densified material show that susceptibility for granulation improves

markedly with the increase in the moisture level. The highest susceptibility for granulation is characteristic of lupine (the highest values of k_1 and the lowest values of k_2 and k_3). In the case of the remaining raw materials, no significant differences in the values of the coefficients was found which proves their similar susceptibility to granulation.

The presented studies were carried out in the framework of the research project No.PB/0589/93/94/07 financed by the Committee for Scientific Research in the period 1994-1996.

REFERENCES

1. David L., Lefumeux J.: Pratique de la compression et techniques nouvelles. David ed., La larrie, 1972.
2. Drzymala Z.: Bases du génie des procédés de compactage et de pressage des matériaux (in Polish). PWN, Warszawa, 1988.
3. Klasiern P. W., Griszajew I. G.: Fundamental of Pelleting Technique (in Polish). WNT, Warszawa, 1989.
4. Laskowski J.: Study on feed pelleting process (in Polish). Wydawnictwo Akademii Rolniczej, Seria Wydawnicza, Rozprawy Naukowe 113, Lublin, 75, 1989.
5. Laskowski J., Skonecki S.: Studies on the granulation mechanism of ground food materials (in Polish). Mat. Konf. nt. „Maszyny w procesach rozdrabniania materiałów rolno-spożywczych”. ATR Bydgoszcz, 22-28, 1992.
6. Laskowski J., Skonecki S.: Agglomeration ability of chosen cereal materials (in Polish). Mat. III ICCE 93 Internationale Conference on Crumblers Engineering. Wyd. Mech. ART Bydgoszcz, 132-136, 1993.
7. Laskowski J., Skonecki S.: The method of determination the biological materials pressure

- agglomeration (in Polish). Mat. III Ogóln. i II Międz. Konf. Nauk. nt. „Rozwój teorii i technologii w technicznej modernizacji rolnictwa”, ART, Olsztyn, 29-33, 1994.
8. **Laskowski J., Skonecki S.:** Computer aiding in studies on the process of pelleting biological materials (in Polish). Zesz. Probl. Post. Nauk Roln., 423, 151-161, 1995.
 9. **Laskowski J., Skonecki S., Gowin J.:** Measuring system for testing machines of type ZD with computer registration and analysis of compression process parameters (in Polish). Zesz. Probl. Post. Nauk Roln., 424, 279-284, 1995.
 10. **Laskowski J., Skonecki S., Melcion J.-P.:** Compression ability of raw biological materials (in Polish). Mat. VI Konf. Nauk. Techn. nt. „Budowa i Eksploatacja Maszyn Przemysłu Spożywczego”. Gdańsk, Wydawn. SITMP w Warszawie, 1, 87-92, 1993.
 11. **Mac Mahon M. J., Payne J. V.:** Guide pour la fabrication de granules. Holmen Chemicals Ltd., 1981.
 12. **Tylżanowski J.:** Production technology of pelleted compound feeds (in Polish). Studium Przemysłu Paszowego, 7, WCT NOT, Warszawa, 1975.