

# A FAST INTRA MODE DECISION ALGORITHM FOR AVS TO H.264 TRANSCODING

Zhihang Wang<sup>1</sup>, Wen Gao<sup>1</sup>, Debin Zhao<sup>1,2</sup>, Qingming Huang<sup>3</sup>

1) Institute of Computing Technology, Chinese Academy of Sciences, Beijing 100080, China

2) Department of Computer Science, Harbin Institute of Technology, Harbin 150001, China

3) Research Center of Digital Media, Graduate School of the Chinese Academy of Sciences, Beijing 100049, China

{zhihangwang, wgao, dbzhao, qmhuang}@jdl.ac.cn

## ABSTRACT

H.264/AVC is the latest video coding standard developed by MPEG and ITU. AVS is the latest video coding standard developed by China. The two new video coding standards will co-exist in the market in the future. So it is necessary to transcode the AVS format to the H.264/AVC format or vice versa. Because the AVS video coding standard is based on the 8x8 block and also uses the intra prediction technology, it is possible to use the AVS intra mode information to predict the H.264/AVC intra mode. In this paper, a fast intra mode decision algorithm was proposed to reduce the computation complexity for AVS to H.264/AVC intra transcoding. The evaluation results show that the proposed algorithm can save at least 50% computation with about 0.1 dB loss in PSNR.

## 1. INTRODUCTION

During the last few years, video coding technologies have developed very fast. With the effort of the world, a new video coding standard, H.264, also known as MPEG-4/AVC was born [1]. The H.264 standard, jointly developed by the ITU-T and the MPEG committees, provides perceptually equivalent quality video at about 1/2 or 1/3 of the bitrate offered by MPEG-2 format. Thus H.264 provides new choice for the market, especially for the HDTV and the mobile TV market. However, the computation complexity of H.264 is so large that it is expensive to implement a real time encoder and decoder [2] [3].

At the same time, another video coding standard, AVS (Audio Video Coding Standard), was developed by China [4]. The video coding scheme of AVS is similar to that of the H.264 and the complexity of AVS is smaller than that of H.264 because AVS only uses the 8x8 block, five intra modes, and other technologies [4] to encode the video sequence. The coding efficiency of AVS is almost the same as that of the H.264 [4]. So AVS is another valuable choice

for the video market. The ISMA (Internet Streaming Media Alliance) decided to make the AVS as another candidate video compression standard besides h.264 for IPTV. It can be seen that the two video coding standards will co-exist in the market which make it necessary to transcode the AVS format to H.264 or vice versa. But so far there is not a paper about the AVS to H.264 transcoding. In this paper, we focus our attention on the intra-frame transcoding which is very important for the transcoding technology. Because both AVS and H.264 use the intra mode prediction technology to improve the coding efficiency, the problem is how to use the AVS intra mode information to speed up the H.264 intra prediction process for the AVS to H.264 transcoding. The introduction of the intra prediction technology in H.264 can be found in [1] [5].

The rest of the paper is organized as follows. Section 2 provides a brief overview of the intra prediction algorithm in AVS. The fast intra mode decision algorithm for the AVS to H.264 transcoding is proposed in Section 3. In section 4, the experiment results of computation complexity reduction and rate-distortion results are given. Finally, section 5 concludes the paper.

## 2. INTRA PREDICTION IN AVS

Figure 1 depicts the framework of AVS, which is similar to that of H.264.

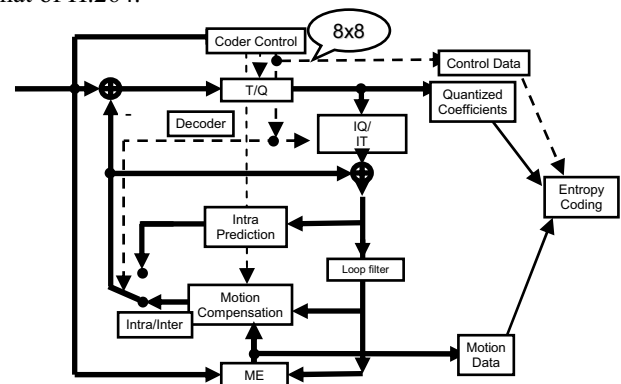

Figure 1. AVS coding framework

The main feature of AVS is the five intra prediction modes for luma and the four intra prediction modes for chroma based on the 8x8 block.

### 2.1 Luma intra prediction

Figure 2 shows the luma intra prediction scheme and figure 3 depicts the luma intra prediction modes. It is clear that the vertical and horizontal modes are the same as those of h.264 except that the block size is 8 by 8. The DC and down-right modes are similar to those of h.264 except the block size and the different filter coefficients. The down-left mode is bidirectional which is very different from that of h.264.

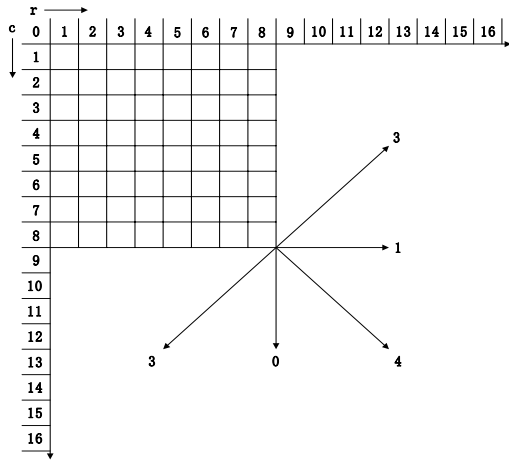

Figure 2. Luma intra prediction direction

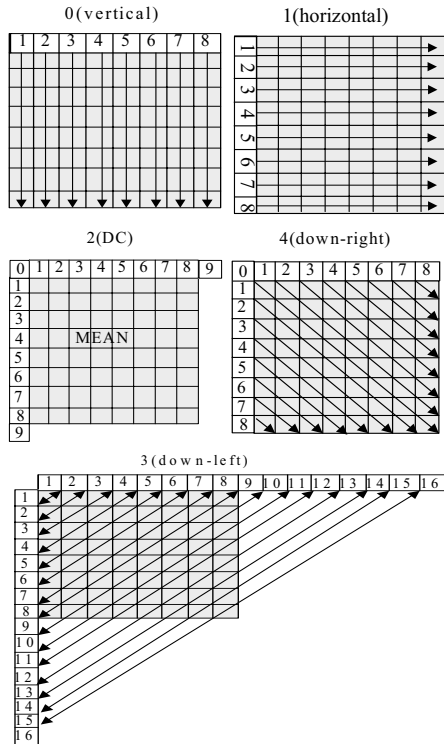

Figure 3. Luma intra prediction modes

### 2.2 Chroma intra prediction mode

The chroma intra prediction mode of AVS consists of four modes: DC, horizontal, vertical, and plane mode. These modes are the same as those of h.264 except the DC mode. More details of intra prediction mode in AVS can be found in [6] [7].

## 3. THE FAST INTRA MODE DECISION ALGORITHM

From section 2, we can know that the intra prediction modes of AVS are very similar to those of h.264, so we can use the mode information of AVS to speed up the intra mode decision process in h.264. It is difficult to predict the final intra prediction mode if we only use the candidate modes. But it is possible to reduce the candidate modes. We will use the mode information of the four 8x8 blocks in one macroblock to speed up the intra mode decision process. Figure 4 shows the scheme of the algorithm. The fast intra mode decision algorithm consists of three parts: the fast luma intra 16x16 mode decision, the fast luma intra 4x4 mode decision and the fast chroma intra mode decision.

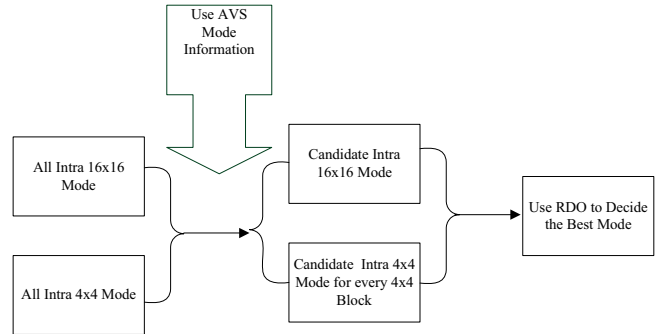

Figure 4. Block diagram of the algorithm

### 3.1 The fast luma intra 16x16 mode decision

First, if the four 8x8 block modes of AVS are different from each other, it means that this macroblock is difficult to predict. Thus we will choose the four intra 16x16 modes exhaustively to decide which mode should be used. Second, if the four 8x8 block modes are the same one except that the mode is down-left or down-right, it shows the high correlation relationship in that direction. So we can predict that this macroblock should choose this intra prediction mode. If the four 8x8 block modes are all down-left, we will only choose the plane prediction mode for h.264 because it means it is effective to predict the macroblock using the filtered up and left pixels. If the four 8x8 block modes are all down-right, we will select the DC prediction mode for h.264. Finally, we will choose all the modes selected by the four 8x8 blocks for this macroblock. It should be noticed that if the 8x8 block selected the down-left mode, we will choose the plane mode. If all the four 8x8 blocks selected

the down-right mode, we will choose the DC mode for the macroblock.

### 3.2 The fast luma intra 4x4 mode decision

Because there are nine luma intra 4x4 prediction modes in h.264, it is difficult to decide which mode should be chosen only depending on the mode information of AVS. If one 8x8 block selected the vertical mode in AVS, it can't assure that the four 4x4 blocks in this 8x8 block should select the vertical intra prediction mode. But we can use the mode information and the SAD (Sum Absolute Difference) of every 4x4 block to predict which mode should be chosen. The block diagram for getting the SAD of every 4x4 block is shown in figure 5.

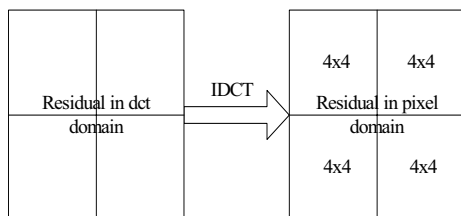

Figure 5. Get the 4x4 block SAD

Then we can predict the 4x4 block mode in h.264 using the residual SAD of this 4x4 block. For example, if the 8x8 block selected the vertical mode and all the 4x4 block residual SADs are zero, then all the 4x4 blocks in this 8x8 block should select vertical mode. In order to speed up the intra mode decision process, we use the threshold method to predict the 4x4 block mode. The block diagram of the algorithm is shown in figure 6 when the 8x8 block selected the vertical or horizontal mode.

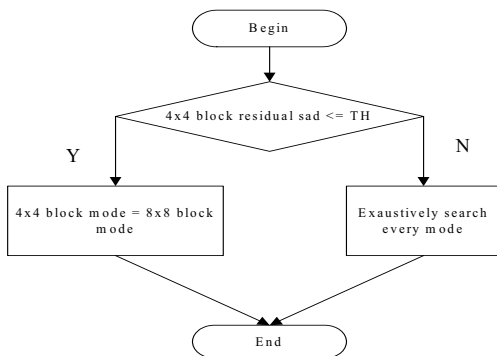

Figure 6. Choose 4x4 block mode when the 8x8 block selected vertical or horizontal mode

Because the vertical and horizontal modes in AVS are identical to those modes in h.264, if the SAD of the residual is very small, all the 4x4 blocks will choose the same mode in h.264. In this paper, we set TH equal to 50. Obviously, the TH is sensitive to QP. TH will change with QP. How to calculate the TH value depending on QP is still needed to be studied.

If the 8x8 block selected the down-left or down-right mode, we will deal with the four 4x4 blocks with different

strategy because there is not a corresponding mode in h.264. Table 1 shows the candidate modes when the 4x4 block residual sad is smaller than or equal to the threshold.

Table 1. Intra 4x4 Candidate Mode

8x8 block mode	Intra 4x4 Mode Index			
	Block0	Block1	Block2	Block3
Down-left	3, 2	3, 7	3, 8	3, 2
Down-right	2, 4	2, 4	2, 4	2, 4

The intra 4x4 mode index in table 1 is identical to [8].

If the 8x8 block selected the DC mode, we will exhaustively search all the candidate modes.

### 3.3 The fast chroma intra mode decision

From section 2.2, we know that only the DC chroma intra prediction mode is different from that of h.264. In order to reduce the coding efficiency loss, the DC chroma intra prediction in h.264 is always selected. Other candidate modes in h.264 are derived depending on the AVS chroma intra mode as shown in table 2.

Table 2. Chroma Intra Mode Mapping

AVS chroma mode	H.264 chroma mode
Vertical	Vertical
Horizontal	Horizontal
DC	Plane
Plane	Plane

As we will show in the following section, the proposed algorithm will significantly reduce the computation complexity while maintain the coding efficiency.

## 4. EXPERIMENT RESULTS

In order to evaluate the proposed intra prediction algorithm, first we encoded the QCIF video sequences using the AVS reference software rm52c with QP=28 to all I frames and decoded the compressed bitstream. Then we encoded the decoded bitstream using the h.264 reference software [9] with and without the proposed algorithm to all I frames. We encoded the decoded bitstream with QP=4, 10, 20, 26, 30, 34, and 38 with RD optimization in order to evaluate the rate-distortion performance at different bitrate.

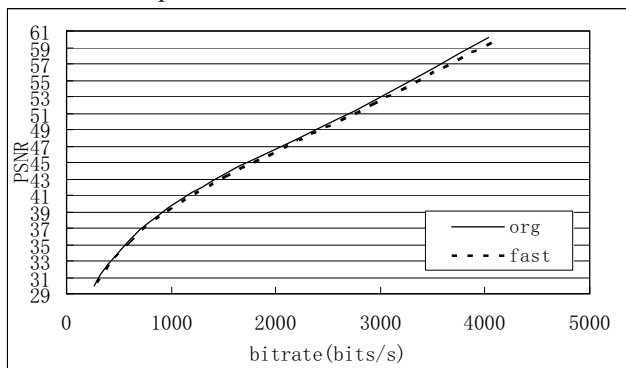

Figure 5. QCIF foreman RD performance (0-199frames)

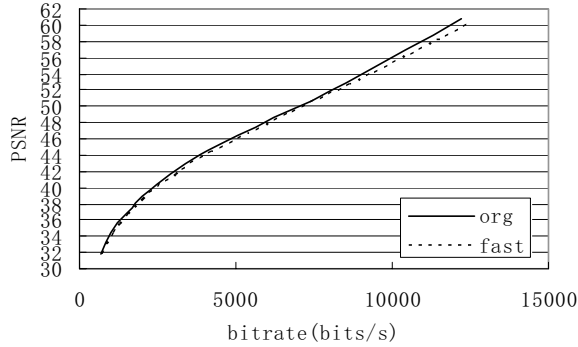

Figure 6. CIF foreman RD performance (0-199frames)

From figure 5 to figure 6 we can see that the loss caused by the fast intra prediction algorithm in rate-distortion curve is negligible. It is because the proper selection of the candidate modes.

Table 3. computation complexity reduction

foreman	QP	org(s)	fast algorithm(s)	reduction
CIF	4	74.949	26.378	65%
	10	69.233	23.912	65%
	20	57.017	19.877	65%
	26	37.697	17.041	55%
	30	34.046	15.498	54%
	34	31.304	14.022	55%
	38	28.928	12.877	55%

Table 4 computation complexity reduction

foreman	QP	org(s)	fast algorithm(s)	reduction
CIF	4	251.269	105.687	58%
	10	223.34	94.918	58%
	20	196.113	77.254	61%
	26	167.704	67.472	60%
	30	152.056	58.419	62%
	34	130.057	54.194	58%
	38	123.88	51.604	58%

Table 3 and table 4 show the saving time using the fast algorithm. It can be seen that the proposed algorithm can reduce the computation at least 50%. It is because the search space for intra mode decision is much smaller than before.

## 5. CONCLUSIONS

In this paper, we propose a fast intra prediction algorithm for AVS to H.264/AVC transcoding. The feature of the proposed algorithm is to efficiently exploit the mode information in AVS to speed up the intra mode decision in h.264. Our experiment results show that the algorithm can significantly reduce the computation while maintain the coding efficiency. This algorithm can be used in the AVS to H.264/AVC transcoder, especially for those real time transcoders. It can also be used with other fast intra mode decision algorithms for h.264 to further speed up the intra mode decision process.

## 6. ACKNOWLEDGMENTS

This work has been supported by Key Technologies for High Efficient Video Coding under the contact no. 60333020 and Key Technologies for Dealing with Streaming Media under the contact no. 4041003.

## 7. REFERENCES

- [1] T. Wiegand, G. Sullivan, G. Bjontegaard, and A. Luthra. "Overview of the H.264/AVC Video Coding Standard," IEEE Transactions on Circuits and Systems for Video Technology, Vol. 13, No. 7, July 2003.
- [2] Implementation Studies Group, "Main Results of the AVC Complexity Analysis," MPEG Document N4964, ISO/IEC JTC1 1/SC29/WG1 1, July 2002.
- [3] Ville Lappalainen, Antti Hallapuro, and Timo D. Hämäläinen "Complexity of Optimized H.26L Video Decoder Implementation", IEEE Transactions on Circuits and Systems for Video Technology, Vol.13, No. 7, July 2003.
- [4] Liang Fan, Siwei Ma and Feng Wu "overview of AVS Video Standard", 2004 IEEE International Conference on Multimedia and Expo(ICME).
- [5] Gerardo Fernandez-Escribano, Pedro Cuenca, Luis Orozco-Barbosa and Antonio Garrido "Computational Complexity Reduction of Intra-Frame Prediction in MPEG-2/H. 264 Video Transcoders", 2005 IEEE International Conference on Multimedia and Expo(ICME) on 06-06 July 2005 Page(s):707 – 710
- [6] Avs\_video\_1.0\_dgb\_20040809.doc, AVS document, Eight, 2004
- [7] AVS reference software rm52c, ftp://159.226.42.57
- [8] Joint Video Team of ITU-T and ISO/IEC JTC 1, "Draft ITU-T Recommendation and Final Draft International Standard of Joint Video Specification (ITU-T Rec. H.264 | ISO/IEC 14496-10 AVC)," Joint Video Team (JVT) of ISO/IEC MPEG and ITU-T VCEG, JVT-G050, March 2003.
- [9] [http://iphome.hhi.de/suehring/tml/download/old\\_jm/jm95.zip](http://iphome.hhi.de/suehring/tml/download/old_jm/jm95.zip)