

On the representation dimension of artin algebras.

Claus Michael Ringel

Abstract. The representation dimension of an artin algebra as introduced by M. Auslander in his Queen Mary Notes is the minimal possible global dimension of the endomorphism ring of a generator-cogenerator. The following report is based on two texts written in 2008 in connection with a workshop at Bielefeld. The first part presents a full proof that any torsionless-finite artin algebra has representation dimension at most 3, and provides a long list of classes of algebras which are torsionless-finite. In the second part we show that the representation dimension is adjusted very well to forming tensor products of algebras. In this way one obtains a wealth of examples of artin algebras with large representation dimension. In particular, we show: The tensor product of n representation-infinite path algebras of bipartite quivers has representation dimension precisely $n + 2$.

Let Λ be an artin algebra. The representation dimension $\text{repdim } \Lambda$ of Λ was introduced 1971 by M. Auslander in his Queen Mary Notes [A], it is the minimal possible global dimension of the endomorphism ring of a generator-cogenerator (a *generator-cogenerator* is a Λ -module M such that any indecomposable projective or injective Λ -module is a direct summand of M); a generator-cogenerator M such that the global dimension of the endomorphism ring of M is minimal will be said to be an *Auslander generator*. All the classes of algebras where Auslander was able to determine the precise representation dimension turned out to have representation dimension at most 3. Thus, he asked, on the one hand, whether the representation dimension can be greater than 3, but also, on the other hand, whether it always has to be finite. These questions have been answered only recently: The finiteness of the representation dimension was shown by Iyama [I1] in 2003 (for a short proof using the notion of strongly quasi-hereditary algebras see [R4]). For some artin algebras Λ , one knows that $\text{repdim } \Lambda \leq \text{LL}(\Lambda) + 1$, where $\text{LL}(\Lambda)$ is the Loewy length of Λ . On the other hand, Rouquier [Rq] has shown that the representation dimension of the exterior algebra of a vector space of dimension $n \geq 1$ is $n + 1$.

The name *representation dimension* was coined by Auslander on the basis of his observation that Λ is representation-finite if and only if $\text{repdim } \Lambda \leq 2$. Not only Auslander, but later also many other mathematicians were able to prove that the representation dimension of many well-known classes of artin algebras is bounded by 3. For artin algebras with representation dimension at most 3, Igusa and Todorov [IT] have shown that the finitistic dimension of these algebras is finite.

Our report is based on two texts written in 2008 in connection with a Bielefeld workshop on the representation dimension [Bi].

Part I is a modified version of [R3] which was written as an introduction for the workshop, it aimed at a general scheme for some of the known proofs for the upper bound 3, by providing the assertion 4.2 that *any torsionless-finite artin algebra has representation dimension at most 3*. We recall that a Λ -module is said to be *torsionless* or *divisible* provided it is a submodule of a projective module, or a factor module of an injective module, respectively. The artin algebra Λ is said to be *torsionless-finite* provided there are only finitely many isomorphism classes of indecomposable torsionless Λ -modules. Two ingredients are needed for the proof of 4.2, one is the characterization 4.3 of Auslander generators which was used already by Auslander (at least implicitly) in the Queen Mary notes, the second is the bijection 3.2 between the isomorphism classes of the indecomposable torsionless and the indecomposable divisible modules which can be found in the appendix of Auslander-Bridger [AB].

In Part II we want to outline that the representation dimension is adjusted very well to forming tensor products of algebras. It should be stressed that already in 2000, Changchang Xi [X1] was drawing the attention to this relationship by showing that

$$\text{repdim } \Lambda \otimes_k \Lambda' \leq \text{repdim } \Lambda + \text{repdim } \Lambda'$$

for finite-dimensional k -algebras Λ, Λ' , provided k is a perfect field. In 2009, Oppermann [O1] gave a lattice criterion for obtaining a lower bound for the representation dimension (see 6.3) and we show (see 7.1) that this lattice construction is compatible with tensor products; this fact was also noted by Oppermann [O4]. In this way one obtains a wealth of examples with large representation dimension. These sections 6 and 7 are after-thoughts to the workshop-lecture of Oppermann and a corresponding text was privately distributed after the workshop. The last two sections show that sometimes one is able to determine the precise value of the representation dimension. Namely, we will show in 9.4: *Let $\Lambda_1, \dots, \Lambda_n$ be representation-infinite path algebras of bipartite quivers. Then the algebra $\Lambda = \Lambda_1 \otimes_k \dots \otimes_k \Lambda_n$ has representation dimension precisely $n+2$* . For quivers without multiple arrows, this result was presented at the Abel conference in Balestrand, June 2011, the example of the tensor product of two copies of the Kronecker algebra was exhibited already by Oppermann at the Bielefeld workshop.

We consider an artin algebra Λ with duality functor D . Usually, we will consider left Λ -modules of finite length and call them just modules. Always, morphisms will be written on the opposite side of the scalars.

Given a class \mathcal{M} of modules, we denote by $\text{add } \mathcal{M}$ the modules which are (isomorphic to) direct summands of direct sums of modules in \mathcal{M} . If M is a module, we write $\text{add } M = \text{add}\{M\}$. We say that \mathcal{M} is *finite* provided there are only finitely many isomorphism classes of indecomposable modules in $\text{add } \mathcal{M}$, thus provided there exists a module M with $\text{add } \mathcal{M} = \text{add } M$.

Acknowledgment. The author is indebted to Dieter Happel and Steffen Oppermann for remarks concerning the presentation of the paper.

Part I. Torsionless-finite artin algebras.

1. The torsionless modules for Λ and Λ^{op}

Let $\mathcal{L} = \mathcal{L}(\Lambda)$ be the class of torsionless Λ -modules and $\mathcal{P} = \mathcal{P}(\Lambda)$ the class of projective Λ -modules. Then $\mathcal{P}(\Lambda) \subseteq \mathcal{L}(\Lambda)$, and we may consider the factor category $\mathcal{L}(\Lambda)/\mathcal{P}(\Lambda)$ obtained from $\mathcal{L}(\Lambda)$ by factoring out the ideal of all maps which factor through a projective module.

(1.1) Theorem. *There is a duality*

$$\eta: \mathcal{L}(\Lambda)/\mathcal{P}(\Lambda) \longrightarrow \mathcal{L}(\Lambda^{\text{op}})/\mathcal{P}(\Lambda^{\text{op}})$$

with the following property: If U is a torsionless module, and $f: P_1(U) \rightarrow P_0(U)$ is a projective presentation of U , then for $\eta(U)$ we can take the image of $\text{Hom}(f, \Lambda)$.

In the proof, we will use the following definition: We call an exact sequence $P_1 \rightarrow P_0 \rightarrow P_{-1}$ with projective modules P_i *strongly exact* provided it remains exact when we apply $\text{Hom}(-, \Lambda)$. Let \mathcal{E} be the category of strongly exact sequences $P_1 \rightarrow P_0 \rightarrow P_{-1}$ with projective modules P_i (as a full subcategory of the category of complexes).

(1.2) Lemma. *The exact sequence $P_1 \xrightarrow{f} P_0 \xrightarrow{g} P_{-1}$, with all P_i projective and epi-mono factorization $g = ue$ is strongly exact if and only if u is a left Λ -approximation.*

Proof: Under the functor $\text{Hom}(-, \Lambda)$, we obtain

$$\text{Hom}(P_{-1}, \Lambda) \xrightarrow{g^*} \text{Hom}(P_0, \Lambda) \xrightarrow{f^*} \text{Hom}(P_1, \Lambda)$$

with zero composition. Assume that u is a left Λ -approximation. Given $\alpha \in \text{Hom}(P_0, \Lambda)$ with $f^*(\alpha) = 0$, we rewrite $f^*(\alpha) = \alpha f$. Now e is a cokernel of f , thus there is α' with $\alpha = \alpha'e$. Since u is a left Λ -approximation, there is α'' with $\alpha' = \alpha''u$. It follows that $\alpha = \alpha'e = \alpha''ue = \alpha''g = g^*(\alpha'')$.

Conversely, assume that the sequence $(*)$ is exact, let U be the image of g , thus $e: P_0 \rightarrow U, u: U \rightarrow P_{-1}$. Consider a map $\beta: U \rightarrow \Lambda$. Then $f^*(\beta e) = \beta e f = 0$, thus there is $\beta' \in \text{Hom}(P_{-1}, \Lambda)$ with $g^*(\beta') = \beta e$. But $g^*(\beta) = \beta'g = \beta'ue$ and $\beta e = \beta'ue$ implies $\beta = \beta'u$, since e is an epimorphism.

Proof of Theorem 1.1. Let \mathcal{U} be the full subcategory of \mathcal{E} of all sequences which are direct sums of sequences of the form

$$P \rightarrow 0 \rightarrow 0, \quad P \xrightarrow{1} P \rightarrow 0, \quad 0 \rightarrow P \xrightarrow{1} P, \quad 0 \rightarrow 0 \rightarrow P.$$

In order to define the functor $q: \mathcal{E} \rightarrow \mathcal{L}$, let $q(P_1 \xrightarrow{f} P_0 \xrightarrow{g} P_{-1})$ be the image of g . Clearly, q sends \mathcal{U} onto \mathcal{P} , thus it induces a functor

$$\bar{q}: \mathcal{E}/\mathcal{U} \longrightarrow \mathcal{L}/\mathcal{P}.$$

Claim: *This functor \bar{q} is an equivalence.*

First of all, the functor q is dense: starting with $U \in \mathcal{L}$, let

$$P_1 \xrightarrow{f} P_0 \xrightarrow{e} U \rightarrow 0$$

be a projective presentation of U , let $u: U \rightarrow P_{-1}$ be a left Λ -approximation of U , and $g = ue$.

Second, the functor q is full. This follows from the lifting properties of projective presentations and left Λ -approximations.

It remains to show that \bar{q} is faithful. We will give the proof in detail (and it may look quite technical), however we should remark that all the arguments are standard; they are the usual ones dealing with homotopy categories of complexes. Looking at strongly exact sequences $P_1 \xrightarrow{f} P_0 \xrightarrow{g} P_{-1}$, one should observe that the image U of g has to be considered as the essential information: starting from U , one may attach to it a projective presentation (this means going from U to the left in order to obtain $P_1 \xrightarrow{f} P_0$) as well as a left Λ -approximation of U (this means going from U to the right in order to obtain P_{-1}).

In order to show that \bar{q} is faithful, let us consider the following commutative diagram

$$\begin{array}{ccccc} P_1 & \xrightarrow{f} & P_0 & \xrightarrow{g} & P_{-1} \\ h_1 \downarrow & & h_0 \downarrow & & h_{-1} \downarrow \\ P'_1 & \xrightarrow{f'} & P'_0 & \xrightarrow{g'} & P'_{-1} \end{array}$$

with strongly exact rows. We consider epi-mono factorizations $g = eu, g' = e'u'$ with $e: P_0 \rightarrow U, u: U \rightarrow P_{-1}, e': P'_0 \rightarrow U', u': U' \rightarrow P'_{-1}$, thus $q(P_\bullet) = U, q(P'_\bullet) = U'$. Assume that $q(h_\bullet) = ab$, where $a: U \rightarrow X, b: X \rightarrow U'$ with X projective. We have to show that h_\bullet belongs to \mathcal{U} .

The factorizations $g = eu, g' = e'u', q(h_\bullet) = ab$ provide the following equalities:

$$eab = h_0e', \quad uh_1 = abu'.$$

Since $u: U \rightarrow P_{-1}$ is a left Λ -approximation and X is projective, there is $a': P_{-1} \rightarrow X$ with $ua' = a$. Since $e': P'_0 \rightarrow U'$ is surjective and X is projective, there is $b': X \rightarrow P'_0$ with $b'e' = b$.

Finally, we need $c: P_0 \rightarrow P'_1$ with $cf' = h_0 - eab'$. Write $f' = w'v'$ with w' epi and v' mono; in particular, v' is the kernel of g' . Note that $eab'g' = eab'e'u' = eabu' = h_0e'u' = h_0g'$, thus $(h_0 - eab')g' = h_0g' - eab'g' = h_0g' - h_0g' = 0$, thus $h_0 - eab'$ factors through the kernel v' of g' , say $h_0 - eab' = c'v'$. Since P_0 is projective and w' is surjective, we find $c: P_0 \rightarrow P'_1$ with $cw' = c'$, thus $cf' = cw'v' = c'v' = h_0 - eab'$.

Altogether, we obtain the following commutative diagram

$$\begin{array}{ccccc}
P_1 & \xrightarrow{f} & P_0 & \xrightarrow{g} & P_{-1} \\
\downarrow [1 \ f] & & \downarrow [1 \ ea] & & \downarrow [a' \ h_1 - a'bu'] \\
P_1 \oplus P_0 & \xrightarrow{\begin{bmatrix} 0 & 0 \\ 1 & 0 \end{bmatrix}} & P_0 \oplus X & \xrightarrow{\begin{bmatrix} 0 & 0 \\ 1 & 0 \end{bmatrix}} & X \oplus P'_{-1} \\
\downarrow \begin{bmatrix} h_1 - fc \\ c \end{bmatrix} & & \downarrow \begin{bmatrix} h_0 - eab' \\ b' \end{bmatrix} & & \downarrow \begin{bmatrix} bu' \\ 1 \end{bmatrix} \\
P'_1 & \xrightarrow{f'} & P'_0 & \xrightarrow{g'} & P'_{-1}
\end{array}$$

which is the required factorization of h_\bullet (here, the commutativity of the four square has to be checked; in addition, one has to verify that the vertical compositions yield the maps h_i ; all these calculations are straight forward).

Now consider the functor $\text{Hom}(-, \Lambda)$, it yields a duality

$$\text{Hom}(-, \Lambda): \mathcal{E}(\Lambda) \longrightarrow \mathcal{E}(\Lambda^{\text{op}})$$

which sends $\mathcal{U}(\Lambda)$ onto $\mathcal{U}(\Lambda^{\text{op}})$. Thus, we obtain a duality

$$\mathcal{E}(\Lambda)/\mathcal{U}(\Lambda) \longrightarrow \mathcal{E}(\Lambda^{\text{op}})/\mathcal{U}(\Lambda^{\text{op}}).$$

Combining the functors considered, we obtain the following sequence

$$\mathcal{L}(\Lambda)/\mathcal{P}(\Lambda) \xleftarrow{\bar{q}} \mathcal{E}(\Lambda)/\mathcal{U}(\Lambda) \xrightarrow{\text{Hom}(-, \Lambda)} \mathcal{E}(\Lambda^{\text{op}})/\mathcal{U}(\Lambda^{\text{op}}) \xrightarrow{\bar{q}} \mathcal{L}(\Lambda^{\text{op}})/\mathcal{P}(\Lambda^{\text{op}}),$$

this is duality, and we denote it by η .

It remains to show that η is given by the mentioned recipe. Thus, let U be a torsionless module. Take a projective presentation

$$P_1 \xrightarrow{f} P_0 \xrightarrow{e} U \rightarrow 0$$

of U , and let $m: U \rightarrow P_{-1}$ be a left \mathcal{P} -approximation of U and $g = eu$. Then

$$P_\bullet = (P_1 \xrightarrow{f} P_0 \xrightarrow{g} P_{-1})$$

belongs to \mathcal{E} and $q(P_\bullet) = U$. The functor $\text{Hom}(-, \Lambda)$ sends P_\bullet to

$$\text{Hom}(P_\bullet, \Lambda) = (\text{Hom}(P_{-1}, \Lambda) \xrightarrow{\text{Hom}(g, \Lambda)} \text{Hom}(P_0, \Lambda) \xrightarrow{\text{Hom}(f, \Lambda)} \text{Hom}(P_1, \Lambda))$$

in $\mathcal{E}(\Lambda^{\text{op}})$. Finally, the equivalence

$$\mathcal{E}(\Lambda^{\text{op}})/\mathcal{U}(\Lambda^{\text{op}}) \xrightarrow{\bar{q}} \mathcal{L}(\Lambda^{\text{op}})/\mathcal{P}(\Lambda^{\text{op}})$$

sends $\text{Hom}(P_\bullet, \Lambda)$ to the image of $\text{Hom}(f, \Lambda)$.

2. Consequences

(2.1) Corollary. *There is a canonical bijection between the isomorphism classes of the indecomposable torsionless Λ -modules and the isomorphism classes of the indecomposable torsionless Λ^{op} -modules.*

Proof: The functor $\text{Hom}(-, \Lambda)$ provides a bijection between the isomorphism classes of the indecomposable projective Λ -modules and the isomorphism classes of the indecomposable projective Λ^{op} -modules. For the non-projective indecomposable torsionless modules, we use the duality η given by Theorem 1.

Remark. As we have seen, there are canonical bijections between the indecomposable projective Λ -modules and the indecomposable projective Λ^{op} -modules, as well between the indecomposable non-projective torsionless Λ -modules and the indecomposable non-projective torsionless Λ^{op} -modules, both bijections being given by categorical dualities, but these bijections do not combine to a bijection with nice categorical properties. We will exhibit suitable examples below.

(2.2) Corollary. *If Λ is torsionless-finite, also Λ^{op} is torsionless-finite.*

Whereas corollaries 2.1 and 2.2 are of interest only for non-commutative artin algebras, the theorem itself is also of interest for Λ commutative.

(2.3) Corollary. *For Λ a commutative artin algebra, the category \mathcal{L}/\mathcal{P} has a self-duality.*

For example, consider the factor algebra $\Lambda = k[T]/\langle T^n \rangle$ of the polynomial ring $k[T]$ in one variable, with k is a field. Since Λ is self-injective, all the modules are torsionless. Note that in this case, η coincides with the syzygy functor Ω .

3. The torsionless and the divisible Λ -modules

Let $\mathcal{K} = \mathcal{K}(\Lambda)$ be the class of divisible Λ -modules. Of course, the duality functor D provides a bijection between the isomorphism classes of divisible modules and the isomorphism classes of torsionless right modules.

We denote by $\mathcal{Q} = \mathcal{Q}(\Lambda)$ the class of injective modules. Clearly, D provides a duality

$$D: \mathcal{L}(\Lambda^{\text{op}})/\mathcal{P}(\Lambda^{\text{op}}) \longrightarrow \mathcal{K}(\Lambda)/\mathcal{Q}(\Lambda).$$

Thus, we can reformulate theorem 1 as follows: *The categories $\mathcal{L}(\Lambda)/\mathcal{P}(\Lambda)$ and $\mathcal{K}(\Lambda)/\mathcal{Q}(\Lambda)$ are equivalent under the functor $D\eta$. It seems to be worthwhile to replace the functor $D\eta$ by the functor $\Sigma\tau$. Here, τ is the Auslander-Reiten translation and Σ is the suspension functor (defined by $\Sigma(V) = I(V)/V$, where $I(V)$ is an injective envelope of V). Namely,*

in order to calculate $\tau(U)$, we start with a minimal projective presentation $f: P_1 \rightarrow P_0$ and take as $\tau(U)$ the kernel of

$$D\text{Hom}(f, \Lambda): D\text{Hom}(P_1, \Lambda) \longrightarrow D\text{Hom}(P_0, \Lambda).$$

Now the kernel inclusion $\tau(U) \subset D\text{Hom}(P_1, \Lambda)$ is an injective envelope of $\tau(U)$; thus $\Sigma\tau(U)$ is the image of $D\text{Hom}(f, \Lambda)$, but this image is $D\eta(U)$. Thus we see that Theorem 1.1 can be formulated also as follows:

(3.1) Theorem. *The categories $\mathcal{L}(\Lambda)/\mathcal{P}(\Lambda)$ and $\mathcal{K}(\Lambda)/\mathcal{Q}(\Lambda)$ are equivalent under the functor $\gamma = \Sigma\tau$.*

(3.2) Corollary. *If Λ is torsionless-finite, the number of isomorphism classes of indecomposable divisible modules is equal to the number of isomorphism classes of indecomposable torsionless modules.*

(3.3) Examples. We insert here four examples so that one may get a feeling about the bijection between the isomorphism classes of indecomposable torsionless modules and those of the indecomposable divisible modules.

(1) The path algebra of a linearly oriented quiver of type A_3 modulo the square of its radical.

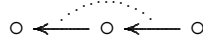

We present twice the Auslander-Reiten quiver. Left, we mark by $+$ the indecomposable torsionless modules and encircle the unique non-projective torsionless module. On the right, we mark by $*$ the indecomposable divisible modules and encircle the unique non-injective divisible module:



(2) Next, we look at the algebra Λ given by the following quiver with a commutative square; to the right, we present its Auslander-Reiten quiver $\Gamma(\Lambda)$ and mark the torsionless and divisible modules as in the previous example. Note that the subcategories \mathcal{L} and \mathcal{K} are linearizations of posets.

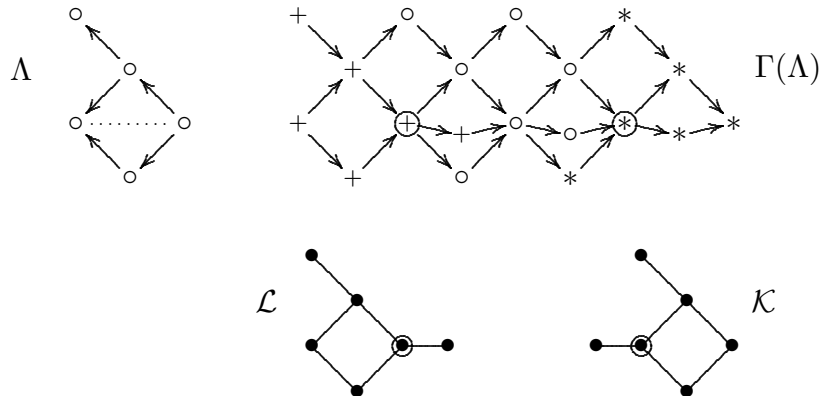

(3) The local algebra Λ with generators x, y and relations $x^2 = y^2$ and $xy = 0$. In order to present Λ -modules, we use here the following convention: the bullets represent base vectors, the lines marked by x or y show that the multiplication by x or y , respectively, sends the upper base vector to the lower one (all other multiplications by x or y are supposed to be zero). The upper line shows all the indecomposable modules in \mathcal{L} , the lower one those in \mathcal{K} .

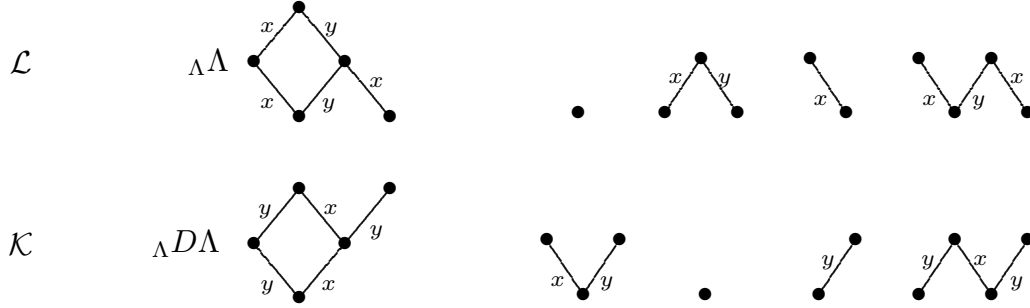

Let us stress the following: All the indecomposable modules in $\mathcal{L} \setminus \mathcal{P}$ as well as those in $\mathcal{K} \setminus \mathcal{Q}$ are Λ' -modules, where $\Lambda' = k[x, y]/\langle x, y \rangle^2$. Note that the category of Λ' -modules is stably equivalent to the category of Kronecker modules, thus all its regular components are homogeneous tubes. In \mathcal{L} we find two indecomposable modules which belong to one tube, in \mathcal{K} we find two indecomposable modules which belong to another tube. The algebra Λ' has an automorphism which exchanges these two tubes; this is an outer automorphism, and it **cannot** be lifted to an automorphism of Λ itself.

(4) In the last example to be presented here, \mathcal{L} (and therefore also \mathcal{K}) will be infinite. We consider the quiver

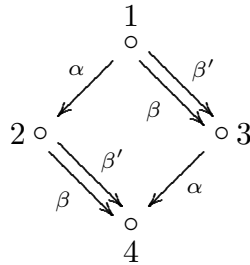

with the relations $\alpha\beta = \beta\alpha$ and $\alpha\beta' = \beta'\alpha$, thus we deal with the tensor product Λ of the Kronecker algebra and the path algebra of the quiver of type \mathbb{A}_2 (note that tensor products of algebras will be discussed in the second part of this paper in more detail). For any vertex i , we denote by $S(i), P(i), Q(i)$ the simple, or indecomposable projective or indecomposable injective Λ -module corresponding to i , respectively.

The categories \mathcal{L} and \mathcal{K} can be described very well using the category of Kronecker modules. By definition, the Kronecker quiver K has two vertices, a source and a sink, and two arrows going from the source to the sink. Thus a Kronecker module is a quadruple (U, V, w, w') consisting of two vector spaces U, V and two linear maps $w, w': U \rightarrow V$. We

define functors $\eta, \eta': \text{mod } kK \rightarrow \text{mod } \Lambda$, sending $M = (U, V, w, w')$ to the representations

$$\eta(M) = \begin{array}{ccc} & 0 & \\ & \swarrow & \searrow \\ V & & U \\ & \searrow \begin{bmatrix} 0 \\ 1 \end{bmatrix} & \swarrow \\ & V \oplus V & \end{array} \quad \eta'(M) = \begin{array}{ccc} & U \oplus U & \\ & \swarrow \begin{bmatrix} w \\ w' \end{bmatrix} & \searrow \begin{bmatrix} 0 & 1 \end{bmatrix} \\ V & & U \\ & \searrow \begin{bmatrix} 1 & 0 \end{bmatrix} & \swarrow \\ & 0 & \end{array}$$

these functors η, η' are full embeddings.

Let us denote by I the indecomposable injective Kronecker module of length 3, by T the indecomposable projective Kronecker module of length 3, then clearly

$$\eta(I) = \text{rad } P(1) \quad \text{and} \quad \eta'(T) = Q(4)/\text{soc},$$

and the dimension vector of $\eta(I)$ is $1_2^0 2$, that of $\eta'(T)$ is $2_0^2 1$. If M is an indecomposable Kronecker module, then either M is simple injective and $\eta(M) = S(3)$, or else M is cogenerated by I , and $\eta(M)$ is cogenerated by $\text{rad } P(1)$, thus $\eta(M)$ is a torsionless Λ -module. Similarly, either M is simple projective and $\eta'(M) = S(2)$, or else M is generated by T and $\eta'(M)$ is generated by $Q(4)/\text{soc}$, so that $\eta'(M)$ is divisible.

On the other hand, nearly all indecomposable torsionless Λ -modules are in the image of the functor η , the only exceptions are the indecomposable projective modules $P(1), P(3), P(4)$. Similarly, nearly all indecomposable divisible Λ -modules are in the image of the functor η' , the only exceptions are the indecomposable injective modules $Q(1), Q(2), Q(4)$.

Altogether, one sees that the category \mathcal{L} has the following Auslander-Reiten quiver

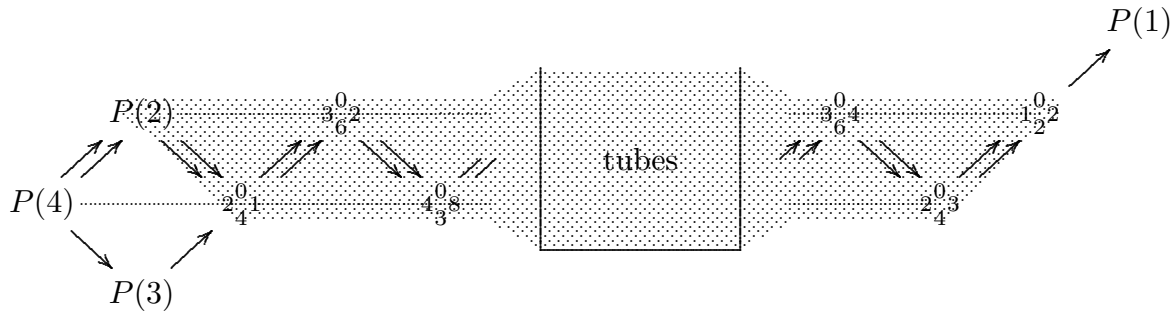

where the dotted part are the torsionless modules which are in the image of the functor η . The category \mathcal{L}/\mathcal{P} is equivalent under η to the category of Kronecker modules without simple direct summands.

Dually, the category \mathcal{K} has the following Auslander-Reiten quiver:

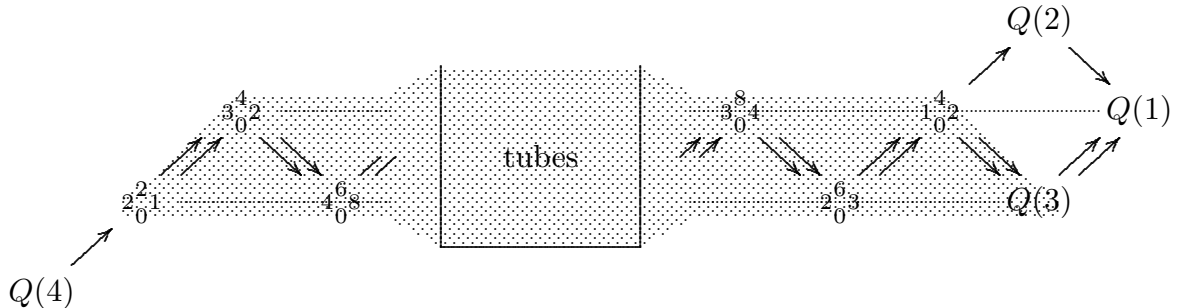

here, the dotted part are the divisible modules which are in the image of the functor η' and we see that now the functor η' furnishes an equivalence between the category \mathcal{K}/\mathcal{Q} and the category of Kronecker modules without simple direct summands.

Let us add an interesting property of the functor γ .

(3.4) Proposition. *Let M be indecomposable, torsionless, but not projective. Then $\text{top } M$ and $\text{soc } \gamma M$ are isomorphic.*

Proof: In order to calculate $\gamma M = \Sigma \tau M$, we start with a minimal projective presentation $f: P_1 \rightarrow P_0$, apply the functor $\nu = D \text{Hom}(-, \Lambda)$ to f and take as γM the image of $\nu(f)$. Here, the embedding of γM into νP_0 is an injective envelope. Since P_0 is a projective cover of M , we have $\text{top } P_0 \simeq \text{top } M$; since νP_0 is an injective envelope of γM , we have $\text{soc } \gamma M \simeq \text{soc } \nu P_0$. And of course, we have $\text{top } P_0 \simeq \text{soc } \nu P_0$.

This property of γ is nicely seen in the last example! Of course, the canonical bijection between the indecomposable projective and the indecomposable injective modules has also this property.

4. The representation dimension of a torsionless-finite artin algebra

(4.1) Theorem. *Let Λ be a torsionless-finite artin algebra. Let M be the direct sum of all indecomposable Λ -modules which are torsionless or divisible, one from each isomorphism class. Then the global dimension of $\text{End}(M)$ is at most 3.*

Note that such a module M is a generator-cogenerator, thus we see: *If Λ is in torsionless-finite and representation-infinite, then the direct sum of all Λ -modules which are torsionless or divisible is an Auslander generator.* In particular:

(4.2) Corollary. *If Λ is a torsionless-finite artin algebra, then $\text{repdim } \Lambda \leq 3$.*

For the proof of Theorem 4.1, we need the following lemma which goes back to Auslander's Queen Mary notes [A] where it was used implicitly. The formulation is due to [EHIS] and [CP]. Given modules M, X , denote by $\Omega_M(X)$ the kernel of a minimal right add M -approximation $g_{MX}: M' \rightarrow X$. By definition, the M -dimension $M\text{-dim } X$ of X is the minimal value i such that $\Omega_M^i(X)$ belongs to $\text{add } M$.

(4.3) Auslander-Lemma. *Let M be a Λ -module. If $M\text{-dim } X \leq d$ for all Λ -modules X , then the global dimension of $\text{End}(M)$ is less or equal $d + 2$. If M is a generator-cogenerator, then also the converse holds: if the global dimension of $\text{End}(M)$ is less or equal $d + 2$ with $d \geq 0$, then $M\text{-dim } X \leq d$ for all Λ -modules X .*

Let us outline the proof of the first implication. Thus, let us assume $M\text{-dim } X \leq d$ for all Λ -modules X . Given any $\text{End}(M)$ -module Y , we want to construct a projective $\text{End}(M)$ -resolution of length at most $d + 2$. The projective $\text{End}(M)$ -modules are of the form $\text{Hom}(M, M')$ with $M' \in \text{add } M$. Consider a projective presentation of Y , thus an exact sequence

$$\text{Hom}(M, M'') \xrightarrow{\phi} \text{Hom}(M, M') \rightarrow Y \rightarrow 0,$$

with $M', M'' \in \text{add } M$. Note that $\phi = \text{Hom}(M, f)$ for some map $f: M'' \rightarrow M'$. Let X be the kernel of f , thus $\text{Hom}(M, X)$ is the kernel of $\text{Hom}(M, f) = \phi$. Inductively, we construct minimal right $\text{add } M$ -approximations

$$M_i \xrightarrow{g_i} \Omega_M^i(X),$$

starting with $\Omega_M^0(X) = X$, so that the kernel of g_i is just Ω_M^{i+1} , say with inclusion map $u_{i+1}: \Omega_M^{i+1} \rightarrow M_i$. Thus, we get a sequence of maps

$$0 \rightarrow \Omega_M^d(X) \xrightarrow{u_d} M_{d-1} \xrightarrow{u_{d-1}g_{d-1}} M_{d-2} \rightarrow \cdots \rightarrow M_1 \xrightarrow{u_1g_1} M_0 \xrightarrow{f_0} X \rightarrow 0$$

If we apply the functor $\text{Hom}(M, -)$ to this sequence, we get an exact sequence

$$0 \rightarrow \text{Hom}(M, \Omega_M^d(X)) \rightarrow \text{Hom}(M, M_{d-1}) \rightarrow \cdots \rightarrow \text{Hom}(M, M_0) \rightarrow \text{Hom}(M, X) \rightarrow 0$$

(here we use that we deal with right M -approximations and that $\text{Hom}(M, -)$ is left exact). Since we assume that $\Omega_M^d(X)$ is in $\text{add } M$, we see that we have constructed a projective resolution of $\text{Hom}(M, X)$ of length d . Combining this with the exact sequence

$$0 \rightarrow \text{Hom}(M, X) \rightarrow \text{Hom}(M, M'') \xrightarrow{\phi} \text{Hom}(M, M') \rightarrow Y \rightarrow 0,$$

we obtain a projective resolution of Y of length $d + 2$. This completes the proof.

(4.4) Proof of Theorem 4.1. As before, let \mathcal{L} be the class of torsionless Λ -modules, and \mathcal{K} be the class of divisible Λ -modules. Since Λ is torsionless-finite there are Λ -modules K, L with $\text{add } K = \mathcal{K}$, and $\text{add } L = \mathcal{L}$. Let $M = K \oplus L$. We use the Auslander Lemma.

Let X be a Λ -module. Let U be the trace of \mathcal{K} in X (this is the sum of the images of maps $K \rightarrow X$). Since \mathcal{K} is closed under direct sums and factor modules, U belongs to \mathcal{K} (it is the largest submodule of X which belongs to \mathcal{K}). Let $p: V \rightarrow X$ be a right \mathcal{L} -approximation of X (it exists, since we assume that \mathcal{L} is finite). Since \mathcal{L} contains all the projective modules, it follows that p is surjective. Now we form the pullback

$$\begin{array}{ccc} V & \xrightarrow{p} & X \\ u' \uparrow & & \uparrow u \\ W & \xrightarrow[p']{} & U \end{array}$$

where $u: U \rightarrow X$ is the inclusion map. With u also u' is injective, thus W is a submodule of $V \in \mathcal{L}$. Since \mathcal{L} is closed under submodules, we see that W belongs to \mathcal{L} . On the other hand, the pullback gives rise to the exact sequence

$$0 \rightarrow W \xrightarrow{[p' \quad -u']} U \oplus V \xrightarrow{\begin{bmatrix} u \\ p \end{bmatrix}} X \rightarrow 0$$

(the right exactness is due to the fact that p is surjective). By construction, the map $\begin{bmatrix} u \\ p \end{bmatrix}$ is a right M -approximation, thus $\Omega_M(X)$ is a direct summand of W and therefore in $\mathcal{L} \subseteq \text{add } M$. This completes the proof.

5. Classes of torsionless-finite artin algebras

In the following, let Λ be an artin algebra with radical J .

Before we deal with specific classes of torsionless-finite artin algebras, let us mention two characterizations of torsionless-finite artin algebras:

(5.1) Proposition. *An artin algebra Λ is torsionless-finite if and only if there exists a faithful module M such that the subcategory of modules cogenerated by M is finite.*

Proof. If Λ is torsionless-finite, we can take $M = {}_{\Lambda}\Lambda$. Conversely, assume that M is faithful and that the subcategory of modules cogenerated by M is finite. Since M is faithful, the regular representation ${}_{\Lambda}\Lambda$ itself is cogenerated by M , thus all the torsionless-finite Λ -modules are cogenerated by M . This shows that Λ is torsionless-finite.

Actually, also non-faithful modules can similarly be used in order to characterize torsionless-finiteness, for example we can take $\text{rad } \Lambda$ (note that for a non-zero artin algebra, $\text{rad } \Lambda$ is never faithful, since it is annihilated by the right socle of Λ):

(5.2) Proposition. *An artin algebra Λ is torsionless-finite if and only if the subcategory of modules cogenerated by J is finite.*

Proof: On the one hand, modules cogenerated by $\text{rad } \Lambda$ are torsionless. Conversely, assume that there are only finitely many isomorphism classes of indecomposable Λ -modules which are cogenerated by $\text{rad } \Lambda$. Then Λ is torsionless-finite, according to following lemma.

(5.3) Lemma. *Let N be an indecomposable torsionless Λ -module. Then either N is projective or else N is cogenerated by J .*

Proof: Let N be indecomposable and torsionless, but not cogenerated by J . We claim that N is projective. Since N is torsionless, there is an inclusion map $u: N \rightarrow P = \bigoplus P_i$ with indecomposable projective modules P_i . Let $\pi_i: P \rightarrow P_i$ be the canonical projection onto the direct summand P_i of P and $\epsilon_i: P_i \rightarrow S_i$ the canonical projection of P_i onto its top. If $\epsilon\pi_i u = 0$ for all i , then N is contained in the radical of P , thus cogenerated by $\text{rad } \Lambda$, a contradiction. Thus there is some index i with $\epsilon\pi_i u \neq 0$, but this implies that $\pi_i u$ is surjective. Since this is a surjective map onto a projective module, we see that $\pi_i u$ is a split epimorphism. But we assume that N is indecomposable, thus $\pi_i u$ is an isomorphism. This shows that $N \simeq P_i$ is projective. Altogether, we see that there are only finitely many isomorphism classes of indecomposable torsionless Λ -modules, namely those cogenerated by $\text{rad } \Lambda$, as well as some additional ones which are projective.

Here are now some classes of torsionless-finite artin algebras:

(5.4) Artin algebras Λ with $\Lambda/\text{soc}(\Lambda_{\Lambda})$ representation-finite. Let N be an indecomposable torsionless Λ -module which is not projective. By Lemma 5.3, there is an embedding $u: N \rightarrow J^t$ for some t . Let $I = \text{soc}(\Lambda_{\Lambda})$. Then $u(IN) = Iu(N) \subseteq I(J^t) = 0$, thus $IN = 0$. This shows that N is a Λ/I -module. Thus N belongs to one of the finitely many isomorphism classes of indecomposable Λ/U -modules. This shows that Λ is torsionless-finite.

If $J^n = 0$ and Λ/J^{n-1} is representation-finite, then Λ is torsionless-finite. Namely, $J^{n-1} \subseteq \text{soc}(\Lambda_\Lambda)$, thus, if Λ/J^{n-1} is representation-finite, also its factor algebra $\Lambda/\text{soc}(\Lambda_\Lambda)$ is torsionless-finite. This shows: *If $J^n = 0$ and Λ/J^{n-1} is representation-finite, then the representation dimension of Λ is at most 3.* (Auslander [A], Proposition, p.143)

(5.5) Artin algebras with radical square zero. Following Auslander (again [A], Proposition, p.143) This is the special case $J^2 = 0$ of 5.4. Of course, here the proof of the torsionless-finiteness is very easy: An indecomposable torsionless module is either projective or simple. Similarly, an indecomposable divisible module is either injective or simple, and any simple module is either torsionless or divisible. Thus the module M exhibited in Theorem 4.1 is the direct sum of all indecomposable projective, all indecomposable injective, and all simple modules.

(5.6) Minimal representation-infinite algebras. Another special case of 5.4 is of interest: We say that Λ is minimal representation-infinite provided Λ is representation-infinite, but any proper factor algebra is representation-finite. If Λ is minimal representation-infinite, and n is minimal with $J^n = 0$, then Λ/J^{n-1} is a proper factor algebra, thus representation-finite.

(5.7) Hereditary artin algebras. If Λ is hereditary, then the only torsionless modules are the projective modules and the only divisible modules are the injective ones, thus the module M of Theorem 4.1 is the direct sum of all indecomposable modules which are projective or injective. In this way, we recover Auslander's result ([A], Proposition, p. 147).

(5.8) Artin algebras stably equivalent to hereditary algebras. Let Λ be stably equivalent to a hereditary artin algebra. Then an indecomposable torsionless module is either projective or simple ([AR1], Theorem 2.1), thus there are only finitely many isomorphism classes of torsionless Λ -modules. Dually, an indecomposable divisible module is either injective or simple. Thus, again we see the structure of the module M of Theorem 4.1 and we recover Proposition 4.7 of Auslander-Reiten [AR2].

(5.9) Right glued algebras (and similarly left glued algebras): An artin algebra Λ is said to be *right glued*, provided the functor $\text{Hom}(D\Lambda, -)$ is of finite length, or equivalently, provided almost all indecomposable modules have projective dimension equal to 1. The condition that $\text{Hom}(D\Lambda, -)$ is of finite length implies that there are only finitely many isomorphism classes of divisible Λ -modules. Also, the finiteness of the isomorphism classes of indecomposable modules of projective dimension greater than 1 implies torsionless-finiteness. We see that *right glued algebras have representation dimension at most 3* (a result of Coelho-Platzcek [CP]).

(5.10) Special biserial algebras without indecomposable projective-injective modules. In order to show that these artin algebras are torsionless-finite, we need the following Lemma.

Lemma. *Let Λ be special biserial and M a Λ -module. The following assertions are equivalent.*

- (i) M is a direct sum of local string modules.

(ii) $\alpha M \cap \beta M = 0$ for arrows $\alpha \neq \beta$.

Proof: (i) \implies (ii). We can assume that M is indecomposable, but then it should condition (ii) is satisfied.

(ii) \implies (i): We can assume that M is indecomposable. For a band module, condition (ii) is clearly not satisfied. And for a string module M , condition (ii) is only satisfied in case M is local.

Proof that special biserial algebras without indecomposable projective-injective modules are torsionless-finite: Assume that Λ is special biserial and that there is no indecomposable projective-injective module. Then all the indecomposable projective modules are string modules (and of course local). Thus any projective module satisfies the condition (i) and therefore also the condition (ii). But if a module M satisfies the condition (ii), also every submodule of M has this property. This shows that all torsionless modules satisfy the condition (ii). It follows that indecomposable torsionless modules are local string modules, and the number of such modules is finite.

It follows from 5.10 that *all special biserial algebras have representation dimension at most 3*, as shown in [EHIS]. For the proof one uses the following general observation (due to [EHIS] in case the representation dimension is 3):

(5.11) Proposition. *Let Λ be an artin algebra. Let P be indecomposable projective-injective Λ -module. There is a minimal two-sided ideal I such that $IP \neq 0$. Let $\Lambda' = \Lambda/I$. Then either Λ' is semisimple or else $\text{repdim } \Lambda \leq \text{repdim } \Lambda'$.*

Proof: Note that all the indecomposable Λ -modules not isomorphic to P are annihilated by I , thus they are Λ' -modules.

First assume that Λ is representation finite, thus $\text{repdim } \Lambda \leq 2$. Now Λ' is also representation finite, and by assumption not semisimple, thus $\text{repdim } \Lambda' = 2$. This yields the claim. (Actually, Λ cannot be semisimple, since otherwise also Λ' semisimple, thus $\text{repdim } \Lambda = 2$ and therefore $\text{repdim } \Lambda = \text{repdim } \Lambda'$.)

Now assume that Λ is not representation finite, with representation dimension d . Let M' be an Auslander generator for Λ' , thus, according the second assertion of the Auslander-Lemma asserts that $M'\text{-dim } X \leq d$ for all Λ' -modules X . Let $M = M' \oplus P$. This is clearly a generator-cogenerator. We want to show the any indecomposable Λ -module has M -dimension at most d (then $\text{End}(M)$ has global dimension at most d and therefore the representation dimension of Λ is at most d).

Let X be an indecomposable Λ -module. Now X may be isomorphic to P , then X is in $\text{add } M$, thus its M -dimension is 0.

So let us assume that X is not isomorphic to P , thus a Λ' -module. Let $g: M'' \rightarrow X$ be a minimal right M' -approximation of X . We claim that g is even a minimal right M -approximation. Now M'' is in $\text{add } M$, thus we only have to show that any map $f: M_i \rightarrow X$ factors through g , where M_i is an indecomposable direct summand of M . This is clear in case M_i is a direct summand of M' , thus we only have to look at the case $M_i = P$. But since X is annihilated by I , the map $f: P \rightarrow X$ vanishes on IP , thus f factors through the projection map $p: P \rightarrow P/IP$, say $f = f'p$ with $f': P/IP \rightarrow X$. Since P/IP

is an indecomposable projective Λ' -module, it belongs to $\text{add } M'$, thus f' factors through g , say $f' = gf''$ for some $f'': P/IP \rightarrow M''$. Thus $f = f'p = gf''p$ factors through g . This concludes the proof that g is a minimal right M -approximation.

Now $\Omega_M(X)$ is the kernel of g , thus $\Omega_M(X) = \Omega_{M'}(X)$, in particular, this is again a Λ' -module. Thus, inductively we see that $\Omega_M^i(X) = \Omega_{M'}^i(X)$ for all i . But we know that $\Omega_M^d(X) = \Omega_{M'}^d(X)$ is in $\text{add } M'$, and $\text{add } M' \subseteq \text{add } M$. This shows that X has M -dimension at most d .

There are many other classes of artin algebras studied in the literature which can be shown to be torsionless-finite, thus have representation dimension at most 3 (note that also Theorem 5.1 of [X1] deals with artin algebras which are divisible-finite, thus torsionless-finite).

(5.12) Further algebras with representation dimension 3. We have seen that many artin algebras of interest are torsionless-finite and thus their representation dimension is at most 3. But we should note that not all artin algebras with representation dimension at most 3 are torsionless-finite.

Namely, it is easy to construct special biserial algebras which are not torsionless-finite. And there are also many tilted algebras as well as canonical algebras which are not torsionless-finite, whereas all tilted and all canonical algebras have representation-dimension at most 3, see Assem-Platzek-Trepode [APT] and Oppermann [O3]. Actually, as Happel-Unger [HU] have shown, all piecewise hereditary algebras have representation dimension at most 3 (an algebra Λ is said to be piecewise hereditary provided the derived category $D^b(\text{mod } \Lambda)$ is equivalent as a triangulated category to the bounded derived category of some hereditary abelian category), but of course not all are torsionless-finite.

Part II. The Oppermann dimension and tensor products of algebras.

We consider now k -algebras Λ , where k is a field.

6. Oppermann dimension.

(6.1) Let $R = k[T_1, \dots, T_d]$ be the polynomial ring in d variables with coefficients in k and $\text{Max } R$ its maximal spectrum, this is the set of maximal ideals of R endowed with the Zariski topology. For example, given $\alpha = (\alpha_1, \dots, \alpha_d) \in k^d$, there is the maximal ideal $\mathfrak{m}_\alpha = \langle T_i - \alpha_i \mid 1 \leq i \leq d \rangle$. In case k is algebraically closed, we may identify in this way k^d with $\text{Max } R$, otherwise k^d yields only part of $\text{Max } R$. In general, we will denote an element of $\text{Max } R$ by α (or also by \mathfrak{m}_α , if we want to stress that we consider α as a maximal ideal), and R_α will denote the corresponding localization of R , whereas $S_\alpha = R/\mathfrak{m}_\alpha$ is the corresponding simple R -module (note that all simple R -modules are obtained in this way). For any ring A , let $\text{fin } A$ be the category of finite length A -modules.

By definition, a $\Lambda \otimes_k R$ -lattice L is a finitely generated $\Lambda \otimes_k R$ -module which is projective (thus free) as an R -module, we also will say that L is a d -dimensional lattice for Λ . Given a $\Lambda \otimes_k R$ -lattice L , we may look at the functor

$$L \otimes_R - : \text{fin } R \longrightarrow \text{mod } \Lambda.$$

Since L_R is projective, this is an exact functor. This means that given an exact sequence of R -modules, applying $L \otimes_R -$ we obtain an exact sequence of Λ -modules. Thus, if M, N are R -modules, and d is a natural number, then looking at an element of $\text{Ext}_R^d(M, N)$, we may interpret this element as the equivalence class $[\epsilon]$ of a long exact sequence ϵ starting with N and ending in M , and we may apply $L \otimes_R -$ to ϵ . We obtain in this way a long exact sequence $L \otimes_R \epsilon$ starting with $L \otimes_R N$ and ending with $L \otimes_R M$ and its equivalence class $[L \otimes_R \epsilon]$ in $\text{Ext}_\Lambda^d(L \otimes_R M, L \otimes_R N)$. Since this equivalence class $[L \otimes_R \epsilon]$ only depends on $[\epsilon]$, we obtain the following function, also denoted by $L \otimes_R -$:

$$L \otimes_R - : \text{Ext}_R^d(M, N) \longrightarrow \text{Ext}_\Lambda^d(L \otimes_R M, L \otimes_R N), \quad \text{with} \quad (L \otimes_R -)[\epsilon] = [L \otimes_R \epsilon].$$

We say that L is a d -dimensional Oppermann lattice for Λ provided the set of $\alpha \in \text{Max } R$ such that

$$(L \otimes_R -) \left(\text{Ext}_R^d(\text{fin } R_\alpha, \text{fin } R_\alpha) \right) \neq 0,$$

is dense in $\text{Max } R$; this means that for these $\alpha \in \text{Max } R$, there are modules $M, N \in \text{fin } R_\alpha$ with

$$(L \otimes_R -) \left(\text{Ext}_R^d(M, N) \right) \neq 0.$$

Actually, instead of looking at all the modules in $\text{fin } R_\alpha$, it is sufficient to deal with the simple module S_α . One knows that $\text{Ext}_R^d(S_\alpha, S_\alpha)$ is generated as a k -space by the equivalence class of a long exact sequence of the form

$$\epsilon_\alpha : \quad 0 \rightarrow S_\alpha \rightarrow M_1 \rightarrow \cdots \rightarrow M_d \rightarrow S_\alpha \rightarrow 0$$

with R_α -modules M_i which are indecomposable and of length 2. If we tensor this exact sequence with L , we obtain an exact sequence

$$L \otimes_R \epsilon_\alpha: \quad 0 \rightarrow L \otimes_R S_\alpha \rightarrow L \otimes_R M_1 \rightarrow \cdots \rightarrow L \otimes_R M_d \rightarrow L \otimes_R S_\alpha \rightarrow 0$$

which yields an equivalence class $[L \otimes_R \epsilon_\alpha]$ in $\text{Ext}_\Lambda^d(L \otimes_R S_\alpha, L \otimes_R S_\alpha)$. It is easy to see that the following conditions are equivalent:

- (i) $(L \otimes_R -) \left(\text{Ext}_R^d(\text{fin } R_\alpha, \text{fin } R_\alpha) \right) \neq 0$,
- (ii) $[L \otimes_R \epsilon_\alpha] \neq 0$ as an element of $\text{Ext}_\Lambda^d(L \otimes_R S_\alpha, L \otimes_R S_\alpha)$.

Thus we see: *The d -dimensional lattice L is an Oppermann lattice for Λ provided the set of $\alpha \in \text{Max } R$ such that $[L \otimes_R \epsilon_\alpha]$ is a non-zero element of $\text{Ext}_R^d(S_\alpha, S_\alpha)$ is dense in $\text{Max } R$.*

By definition, the *Oppermann dimension* $\text{Odim } \Lambda$ of Λ is the supremum of d such that there exists a d -dimensional Oppermann lattice L for Λ .

(6.2) Examples.

- (a) *Let Λ be the path algebra of a representation-infinite quiver. Then $\text{Odim } \Lambda = 1$.*
- (b) *Let Λ be a representation-infinite k -algebra, where k is an algebraically closed field. Then $\text{Odim } \Lambda \geq 1$.*

Proof. (a) The usual construction of one-parameter families of indecomposable Λ -modules for a representation-infinite quivers shows that $\text{Odim } \Lambda \geq 1$. On the other hand, the path algebra of a quiver is hereditary, thus $\text{Ext}_\Lambda^2 = 0$. This shows that the Oppermann dimension can be at most 1.

(b) This follows from the proof of the second Brauer-Thrall conjecture by Bautista [Bt] and [Bo], see also [Bo2] and [R5], [R6].

The following result of Oppermann ([O1], Corollary 3.8) shows that $\text{Odim } \Lambda$ is always finite and that one obtains in this way an interesting lower bound for the representation dimension:

(6.3) Theorem (Oppermann). *Let Λ be a finite-dimensional k -algebra which is not semisimple. Then*

$$\text{Odim } \Lambda + 2 \leq \text{repdim } \Lambda.$$

One may ask whether one always has the equality $\text{Odim } \Lambda + 2 = \text{repdim } \Lambda$, this can be considered as a formidable extension of the assertion of the second Brauer-Thrall conjecture.

7. Tensor products of artin algebras.

Quite a long time ago, Changchang Xi [X1] has shown the following inequality: Given finite-dimensional k -algebras Λ, Λ' ,

$$\text{repdim } \Lambda \otimes_k \Lambda' \leq \text{repdim } \Lambda + \text{repdim } \Lambda',$$

provided k is a perfect field. This provides an upper bound for the representation dimension of $\Lambda \otimes_k \Lambda'$. But there is also a lower bound, which uses the Oppermann dimension. Let us draw attention to the following fact:

(7.1) Theorem. *Let Λ, Λ' be finite-dimensional k -algebras. Let L be an Oppermann lattice for Λ and L' an Oppermann lattice for Λ' . Then $L \otimes_k L'$ is an Oppermann lattice for $\Lambda \otimes_k \Lambda'$.*

Proof: Theorem 7.1 is an immediate consequence of Theorem 3.1 in Chapter XI of Cartan-Eilenberg [CE].

Namely, let L be a d -dimensional Oppermann lattice for Λ and L' a d' -dimensional Oppermann lattice for Λ' . Thus, L is an R -lattice with $R = k[T_1, \dots, T_d]$ and say L' is an R' -lattice, where $R' = k[T'_1, \dots, T'_{d'}]$ (with new variables T'_i). For $\alpha \in \text{Max } R$ we choose an exact sequence ϵ_α such that its equivalence class $[\epsilon_\alpha]$ generates $\text{Ext}_R^d(S_\alpha, S_\alpha)$; similarly, for $\alpha' \in \text{Max } R'$ we choose an exact sequence $\epsilon_{\alpha'}$ such that its equivalence class $[\epsilon_{\alpha'}]$ generates $\text{Ext}_{R'}^{d'}(S_{\alpha'}, S_{\alpha'})$;

Since L is an Oppermann lattice for Λ , the set of elements $\alpha \in \text{Max } R$ such that $[L \otimes_R \epsilon_\alpha] \neq 0$ is dense in $\text{Max } R$. Similarly, since L' is an Oppermann lattice for Λ' , the set of elements $\alpha' \in \text{Max } R'$ such that $[L' \otimes_{R'} \epsilon_{\alpha'}] \neq 0$ is dense in $\text{Max } R'$.

Now $L \otimes_k L'$ is a $\Lambda' \otimes_k \Lambda \otimes_k R \otimes_k R'$ -lattice and we may look at

$$(L \otimes_k L') \otimes_{R \otimes R'} (\epsilon_\alpha \vee \epsilon_{\alpha'}).$$

We claim that its equivalence class is non-zero in $\text{Ext}_{\Lambda \otimes_k \Lambda'}^{d+d'}(S_{(\alpha, \alpha')}, S_{(\alpha, \alpha')})$. This is a special case of Theorem XI.3.1 of Cartan-Eilenberg which asserts the following: Let Λ, Λ' be left noetherian k -algebras, where k is a semisimple commutative ring. Let M be a finitely generated Λ -module and M' a finitely generated Λ' -module. Then the canonical map

$$\vee: \text{Ext}_\Lambda^d(M, N) \otimes_k \text{Ext}_{\Lambda'}^{d'}(M', N') \longrightarrow \text{Ext}_{\Lambda \otimes_k \Lambda'}^{d+d'}(M \otimes_k M', N \otimes_k N')$$

is an isomorphism for any Λ -module N , Λ' -module N' and all $d, d' \in \mathbb{N}$.

It remains to note that for dense subsets X of $\text{Max } R$ and X' of $\text{Max } R'$, the product $X \times X'$ is of course dense in $\text{Max } R \otimes_k R'$.

(7.2) Corollary. *Let Λ, Λ' be finite-dimensional k -algebras. Then*

$$\text{Odim } \Lambda \otimes_k \Lambda' \geq \text{Odim } \Lambda + \text{Odim } \Lambda'.$$

Note that it is easy to provide examples where we have strict inequality: just take representation-finite algebras Λ, Λ' such that the Oppermann dimension of $\Lambda \otimes_k \Lambda'$ is at least 1, for example consider $\Lambda = \Lambda' = k[T]/\langle T^2 \rangle$, or take Λ, Λ' path algebra of quivers of type \mathbb{A}_n with $n \geq 3$. Note that the representation type of the tensor product of any two nonsimple connected k -algebras with k an algebraically closed field, has been determined by Leszczyński and A.Skowroński [LS].

The combination of the inequalities 6.3 and 7.2 yields:

(7.3) Corollary. *Let $\Lambda_1, \dots, \Lambda_n$ be finite-dimensional k -algebras. Then*

$$\text{repdim } \Lambda_1 \otimes_k \cdots \otimes_k \Lambda_n \geq 2 + \sum_{i=1}^n \text{Odim } \Lambda_i.$$

In particular, we see: *Let Λ be the tensor product of n k -algebras with Oppermann dimension greater or equal to 1. Then $\text{repdim } \Lambda \geq n + 2$. Using 6.2, we see:*

(7.4) Corollary.

- (a) *If Λ is the tensor product of n path algebras of representation-infinite quivers, then $\text{repdim } \Lambda \geq n + 2$.*
- (b) *If k is an algebraically closed field and Λ is the tensor product of n representation-infinite k -algebras, then $\text{repdim } \Lambda \geq n + 2$.*

As Happel has pointed out, the following remarkable consequence should be stressed: If Λ_1, Λ_2 are representation-infinite path algebras, then $\Lambda_1 \otimes \Lambda_2$ is never a tilted algebra. After all, tilted algebras have representation dimension at most 3, whereas we have shown that $\text{repdim } \Lambda_1 \otimes_k \Lambda_2 \geq 4$.

8. Nicely tiered algebras.

Let Q be a finite connected quiver. We say that Q is *tiered with $n + 1$ tiers* provided there is a surjective function $l: Q_0 \rightarrow [0, n] = \{z \in \mathbb{Z} \mid 0 \leq z \leq n\}$ such that for any arrow $x \rightarrow y$ one has $l(x) = l(y) + 1$. Such a function l , if it exists, is uniquely determined and is called the *tier function* for Q and $l(x)$ is said to be the *tier* (or the tier number) of the vertex x . We say that Q is *nicely tiered with $n + 1$ tiers* provided Q is tiered with $n + 1$ tiers, say with tier function l such that $l(x) = 0$ for all sinks x , and $l(x) = n$ for all sources x . Clearly, Q is nicely tiered if and only if Q has no oriented cyclic paths and any maximal path has length n . The tier function l of a nicely tiered quiver Q can be characterized as follows: the tier number $l(x)$ of a vertex x is the length of any maximal path starting in x .

Let Q be a nicely tiered quiver and M a representation of Q . We denote by $M|[a, b]$ the restriction of M to the subquiver of all vertices x with $a \leq l(x) \leq b$. We say that a module lives in the interval $[a, b]$ provided $M = M|[a, b]$. We say that a module M is generated in tier a provided its top lives in $[a, a]$. Dually, M is said to be cogenerated in tier a provided its socle lives in $[a, a]$. Given a module M , and $t \in \mathbb{N}_0$, let ${}_tM$ be its t -th socle (thus, there is the sequence of submodules

$$0 = {}_0M \subseteq {}_1M \subseteq \cdots \subseteq {}_tM \subseteq M$$

such that ${}_tM/{}_{t-1}M = \text{soc } M/{}_{t-1}M$ for all $t \geq 1$).

We say that an algebra is *nicely tiered* provided it is given by a nicely tiered quiver and a set of commutativity relations. Let Λ be nicely tiered. Then it follows: local submodules of projective modules are projective, colocal factor modules of injective modules are injective.

In particular: the socle of any projective module has support at some of the sinks, the top of any injective module has support at some of the sources. The Loewy length of a nicely tiered algebra with $n + 1$ tiers is precisely $n + 1$. Of special interest is the following: *For a nicely tiered algebra, any indecomposable module which is projective or injective is solid* (an indecomposable module over an artin algebra is said to be *solid* provided its socle series coincides with its radical series).

(8.1) Proposition. *Let Λ be nicely tiered algebra with $n + 1$ tiers. Assume that the following conditions are satisfied for all indecomposable projective modules P, P' of Loewy length at least 3:*

- (P1) *The module ${}_2P$ is a brick* (this means that any non-zero endomorphism is an automorphism).
- (P2) *If $\text{Hom}({}_2P, {}_2P') \neq 0$, then P can be embedded into P' .*

Let M be the direct sum of the modules ${}_tP$ with P indecomposable projective and $t \geq 2$ as well as the modules ${}_tQ$ with Q indecomposable injective, and $t \geq 1$. Then $\text{End}(M)$ has global dimension at most $n + 2$.

Remark. Note that the module M considered in 8.1 is both a generator and a cogenerator, thus the number $n + 2$ is an upper bound for the representation dimension of Λ . Here we encounter again a class of algebras Λ where one now knows that $\text{repdim } \Lambda \leq \text{LL}(\Lambda) + 1$.

The proof of Proposition 8.1 follows the strategy of Iyama's proof [I] of the finiteness of the representation dimension, as well as subsequent considerations by Oppermann [O1], Corollary A1 (but see already [A] as well as several joint papers with Dlab). It relies on the following lemma shown in [R4]:

(8.2) Lemma. *Let*

$$\emptyset = \mathcal{M}_{-1} \subseteq \mathcal{M}_0 \subseteq \cdots \subseteq \mathcal{M}_{n+1} = \mathcal{M}$$

be finite sets of indecomposable Λ -modules. Let M be a Λ -module with $\text{add } M = \text{add } \mathcal{M}$ and $\Gamma = \text{End}(M)$.

Assume that for any $N \in \mathcal{M}_i$ there is a monomorphism $u: \alpha N \rightarrow N$ with $\alpha N \in \text{add } \mathcal{M}_{i-1}$ such that any radical map $\phi: N' \rightarrow N$ with $N' \in \mathcal{M}_i$ factors through u .

Then the global dimension of Γ is at most $n + 2$.

Let us outline the proof of 8.2. We consider the indecomposable projective Γ -modules $\text{Hom}(M, N)$, where N is indecomposable in \mathcal{M} . Assume that N belongs to \mathcal{M}_i and not to \mathcal{M}_{i-1} , for some i . Since N is not in \mathcal{M}_{i-1} , we see that u is a proper monomorphism. Let $\Delta(N)$ be the cokernel of $\text{Hom}(M, u)$, thus we deal with the exact sequence

$$0 \rightarrow \text{Hom}(M, \alpha N) \xrightarrow{\text{Hom}(M, u)} \text{Hom}(M, N) \rightarrow \Delta(N) \rightarrow 0.$$

We see that $\Delta(N)$ is the factor space of $\text{Hom}(M, N)$ modulo those maps $M \rightarrow N$ which factor through u , thus through $\text{add } \mathcal{M}_{i-1}$.

The assumption that any radical map $\phi: N' \rightarrow N$ with $N' \in \mathcal{M}_i$ factors through u means the following: if we consider $\Delta(N)$ as a Γ -module, then it has one composition

factor of the form $S(N) = \text{top Hom}(M, N)$, all the other composition factors are of the form $S(N') = \text{top Hom}(M, N')$ with N' an indecomposable module in \mathcal{M} which does not belong to \mathcal{M}_i .

Since αN belongs to $\text{add } \mathcal{M}_{i-1}$, the projective Γ -module $\text{Hom}(M, \alpha N)$ is a direct sum of modules $\text{Hom}(M, N')$ with N' in \mathcal{M}_{i-1} .

This shows that Γ is left strongly quasi-hereditary with $n + 2$ layers, thus has global dimension at most $n + 2$, according to [R4].

(8.3) Proof of 8.1. Let Λ be a nicely tiered algebra with $n + 1$ tiers such that the conditions (P1) and (P2) are satisfied.

The conditions (P1) and (P2) imply that corresponding properties are satisfied for ${}_t P$ with $t > 2$.

(P1_t) The module ${}_t P$ is a brick.

(P2_t) If $\text{Hom}({}_t P, {}_t P') \neq 0$, then P can be embedded into P' .

Proof: Let $f: {}_t P \rightarrow {}_t P'$ be a non-zero homomorphism. Then also $f|_{{}_2 P}$ is non-zero, since otherwise f would vanish at the tier 0, but the socle of P lives at the tier 0. Thus, any non-zero endomorphism of ${}_t P$ yields a non-zero endomorphism of ${}_2 P$, by (P1) this is an isomorphism; but if $f|_{{}_2 P}$ has zero kernel, the same is true for $f: {}_2 P \rightarrow {}_2 P'$; thus f is a mono endomorphism, therefore an automorphism. This shows (P1_t). Similarly, if $f: {}_t P \rightarrow {}_t P'$ is non-zero, then also $f|_{{}_2 P}$ is non-zero, therefore P can be embedded into P' by (P2).

We define sets of indecomposable modules $\mathcal{P}^i, \mathcal{Q}_i$ as follows:

Let \mathcal{P}^i be the set of modules ${}_t P$, where P is indecomposable projective, $t \geq 2$ and $\text{LL}(P) - t = i$. The modules in \mathcal{P}^i are indecomposable, according to condition (P1), see 8.1. The non-empty sets \mathcal{P}^i are $\mathcal{P}^0, \mathcal{P}^1, \dots, \mathcal{P}^{n-1}$; the modules in \mathcal{P}^0 are the indecomposable projective modules which are not simple, those in \mathcal{P}^{n-1} are the modules of the form ${}_2 P$ with P generated at tier n .

Let us collect some properties of the modules N in \mathcal{P}^i . Such a module is generated at tier g with $1 \leq g \leq n - i$. (Namely, if P is indecomposable projective, then ${}_t P$ is of Loewy length t , thus generated at $g = t - 1$. Since $t \geq 2$, we have $g \geq 1$. Since P is of length $l \leq n + 1$, we have $t = l - i \leq n + 1 - i$, thus $g = t - 1 \leq n - i$.) The module N lives in $[0, n - i]$ (since it is generated at tier $g \leq n - i$), its socle lives at the vertices with tier 0, and the Loewy length of such a module N satisfies $2 \leq \text{LL}(N) \leq n - i + 1$.

Let \mathcal{Q}_i be the set of non-zero modules ${}_i Q$ with Q indecomposable injective and $i \leq \text{LL}(Q)$. If Q is cogenerated at tier j , where $0 \leq j \leq n$, then $\text{LL}(Q) = n - j + 1$, thus $1 \leq i \leq n - j + 1$ implies that $0 \leq j \leq n - i + 1$. The non-empty sets \mathcal{Q}_i are $\mathcal{Q}_1, \dots, \mathcal{Q}_{n+1}$. The modules in \mathcal{Q}_1 are just all the simple modules.

Since $i \geq 1$, the module ${}_i Q$ is a non-zero submodule of Q , thus has simple socle and therefore is indecomposable. And again, we mention some additional properties for a module N in \mathcal{Q}_i . It is generated at tier g with $i - 1 \leq g \leq n$, it lives in $[i - 1, n]$ and its Loewy length is precisely i .

Claim: *If N is in \mathcal{P}^i , then either $\text{rad } N$ belongs to \mathcal{P}^{i+1} , or else $\text{rad } N$ is semisimple and thus belongs to $\text{add } \mathcal{Q}_1$. If N in \mathcal{Q}_i with $i \geq 2$, then $\text{rad } N$ belongs to \mathcal{Q}_{i-1} .*

Proof: Let P be indecomposable projective of length l . If $t = l - i \geq 3$, then $N = {}_tP$ belongs to \mathcal{P}^i and $\text{rad } N = {}_{t-1}P$ belongs to \mathcal{P}^{i+1} . If $t = l - i = 2$, then $N = {}_tP$ has Loewy length 2, thus $\text{rad } N = {}_1P$ is semisimple, and thus belongs to $\text{add } \mathcal{Q}_1$.

On the other hand, for $N = {}_iQ$, we have $\text{rad } N = {}_{i-1}Q$, and $n - i + 1 < n - (i - 1) - 1$.

Now, let \mathcal{M}_i be the union of all the sets \mathcal{P}^j with $j \geq n + 2 - i$ as well as the sets \mathcal{Q}_j with $j \leq i$. Thus,

$$\begin{aligned}
\mathcal{M}_{n+2} &= \mathcal{P}^0 && \cup \mathcal{M}_{n+1} \\
\mathcal{M}_{n+1} &= \mathcal{P}^1 && \cup \mathcal{Q}_{n+1} \cup \mathcal{M}_n \\
\mathcal{M}_n &= \mathcal{P}^2 && \cup \mathcal{Q}_n \cup \mathcal{M}_{n-1} \\
&\dots && \\
\mathcal{M}_i &= \mathcal{P}^{n+2-i} \cup \mathcal{Q}_i && \cup \mathcal{M}_{i-1} \\
&\dots && \\
\mathcal{M}_3 &= \mathcal{P}^{n-1} \cup \mathcal{Q}_3 && \cup \mathcal{M}_2 \\
\mathcal{M}_2 &= && \mathcal{Q}_2 \cup \mathcal{M}_1 \\
\mathcal{M}_1 &= && \mathcal{Q}_1 \\
\mathcal{M}_0 &= && \emptyset
\end{aligned}$$

As we have shown: If N belongs to \mathcal{M}_i for some i , then $\text{rad } N$ is in $\text{add } \mathcal{M}_{i-1}$. Thus, let $\alpha N = \text{rad } N$ and $u: \alpha N \rightarrow N$ the inclusion map. We want to verify that we can apply Lemma 8.2.

Thus, we have to show that for $N \in \mathcal{M}_i$ any non-zero radical map $f: N' \rightarrow N$ with $N' \in \mathcal{M}_i$ maps into $\text{rad } N$. We can assume that $N \notin \mathcal{M}_{i-1}$, thus N belongs either to \mathcal{P}^{n+2-i} or to \mathcal{Q}_i .

First, let us assume that $N \in \mathcal{Q}_i$, thus N has Loewy length i . If $N' \in \mathcal{P}^{n+2-j}$ with $j \leq i$, then, N' has Loewy length at most $n - (n + 2 - j) + 1 = j - 1 \leq i - 1$. Similarly, if $N' \in \mathcal{Q}_j$, with $j < i$, then the Loewy length of N' is at most $i - 1$. In both cases, we see that the image of any map $f: N' \rightarrow N$ lies in $\text{rad } N$. Thus, it remains to consider the case that $N' \in \mathcal{Q}_i$, so that N' has also Loewy length i . Now N' has a simple socle. If f vanishes on the socle, then again the image of f has socle length at most $i - 1$ and thus lies in $\text{rad } N$. If f does not vanish on the socle, then f is a monomorphism. But N' is relative injective in the subcategory of all modules of Loewy length at most i , thus f is a split monomorphism, thus not a radical morphism.

Second, we assume that $N \in \mathcal{P}^{n+2-i}$. First, consider the case that $N' \in \mathcal{Q}_j$ with $j \leq i$. Now the socle of N lives at tier 0, thus the image of f (and therefore N' itself) must have a composition factor at tier 0. This shows that $N' = {}_jQ$ with Q the injective envelope of a simple at tier 0 and that f is injective. Assume that the image of f does not lie in $\text{rad } N$, then the Loewy length of N has to be equal to j . But ${}_jQ$ is relative injective in the subcategory of all modules of Loewy length at most j , thus $f: N' \rightarrow N$ is a split mono, thus not a radical map.

Finally, there is the case that $N' \in \mathcal{P}^{n+2-j}$ with $j \leq i$. Let $N = {}_tP$ and $N' = {}_{t'}P'$ with P of Loewy length l and P' of Loewy length l' . If $t' < t$, then $f: {}_{t'}P' \rightarrow {}_tP$ maps

into the radical of ${}_tP$. If $t' > t$, then $\text{Hom}({}_{t'}P', {}_tP) = 0$, since ${}_{t'}P'$ is generated at the tier t' , and ${}_tP$ lives at the tiers $[0, t]$. Thus, we can assume that $t' = t$. Since $j \leq i$, we see that $\text{LL}(P') = n + 2 - j + t \geq n + 2 - i + t = \text{LL}(P)$. If $\text{Hom}({}_tP', {}_tP) \neq 0$, then P' can be embedded into P , according to condition (P1), thus $\text{LL}(P') \leq \text{LL}(P)$ and therefore $\text{LL}(P') = \text{LL}(P)$. But if P' is isomorphic to a submodule of P and both have the same Loewy length, then P' and P are isomorphic and therefore also ${}_tP'$ and ${}_tP$ are isomorphic. But then we use (P1_t) in order to see that any non-zero homomorphism ${}_tP' \rightarrow {}_tP$ is an isomorphism. This contradicts the assumption that there is a non-zero radical map ${}_tP' \rightarrow {}_tP$.

Remark. One should be aware that the classes \mathcal{P}^j and \mathcal{Q}_i are not necessarily disjoint. A typical example is the fully commutative square

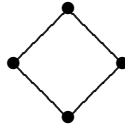

(say with arrows pointing downwards). This is a nicely tiered algebra with 3 tiers. There is an indecomposable module P which is projective-injective, it belongs both to \mathcal{P}^0 and to \mathcal{Q}_3 .

(8.4) Let us add some examples of nicely tiered algebras which do not satisfy the conditions (P1), (P2), respectively. Again, we present the quivers by just indicating the corresponding edges; all the arrows are supposed to point downwards.

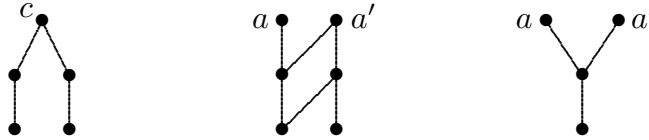

In the example left, ${}_2P(c)$ is decomposable. In the middle example, we consider the path algebra of the quiver with the commutativity relation. Then both ${}_2P(a)$ and ${}_2P(a')$ are indecomposable. We see that $\text{Hom}({}_2P(a), {}_2P(a')) \neq 0$, but $P(a)$ cannot be embedded into $P(a')$. On the right, we see a further example where the condition (P1), but not the condition (P2) is satisfied.

9. Tensor products of path algebras of bipartite quivers.

Recall that a finite quiver is said to be *bipartite* if and only if every vertex is a sink or a source. Thus, a quiver Q is bipartite if and only if its path algebra is a finite dimensional algebra with radical square zero.

(9.1) **Theorem.** *Let $\Lambda_1, \dots, \Lambda_n$ be path algebras of bipartite quivers. Then the algebra $\Lambda = \Lambda_1 \otimes_k \dots \otimes_k \Lambda_n$ has representation dimension at most $n + 2$.*

For the proof, we want to use Proposition 8.1. Of course, we can assume that all the algebras Λ_i are connected and not simple, thus tiered with precisely 2 tiers. In order to show that Λ is tiered with $n + 1$ tiers, we use induction and the following general result:

(9.2) *The tensor product of nicely tiered algebras with $n_1 + 1$ and $n_2 + 1$ tiers respectively is nicely tiered with $n_1 + n_2 + 1$ tiers.*

Proof. Let Λ_1 and Λ_2 be nicely tiered algebras with $n_1 + 1$ and $n_2 + 1$ tiers, respectively. Let $Q^{(1)}$ be the quiver of Λ_1 and $Q^{(2)}$ that of Λ_2 . Then the quiver of $\Lambda_1 \otimes_k \Lambda_2$ is $Q = Q^{(1)} \otimes Q^{(2)}$, this is the quiver with vertex set $Q_0^{(1)} \times Q_0^{(2)}$, and with arrow set $(Q_1^{(1)} \times Q_0^{(2)}) \cup (Q_0^{(1)} \times Q_1^{(2)})$; here, given an arrow $\alpha_1: x_1 \rightarrow y_1$ in $Q^{(1)}$, and a vertex z_2 of $Q^{(2)}$, there is the arrow $\alpha_1 z_2: x_1 z_2 \rightarrow y_1 z_2$, and similarly, given a vertex x_1 of $Q^{(1)}$ and an arrow $\beta_2: y_2 \rightarrow z_2$ in $Q^{(2)}$, there is the arrow $x_1 \beta_2: x_1 y_2 \rightarrow x_1 z_2$. (When writing down an element of a product $U \times V$, we just write uv instead of (u, v) , for $u \in U$ and $v \in V$.)

For example, in case we consider the tensor product of two copies of the Kronecker algebra, say with quivers $Q^{(1)}$ and $Q^{(2)}$, we obtain the following quiver $Q = Q^{(1)} \otimes Q^{(2)}$:

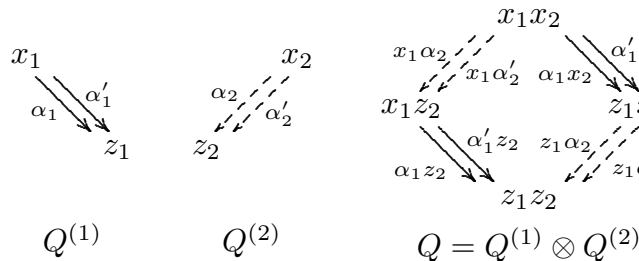

Here, the arrows of $Q^{(1)}$ as well as those of Q which belong to $Q_1^{(1)} \times Q_0^{(2)}$ are shown as solid arrows, those of $Q^{(2)}$ as well as those of Q which belong to $Q_0^{(1)} \times Q_1^{(2)}$ are shown as dashed ones.

Now suppose that $Q^{(1)}, Q^{(2)}$ are nicely tiered, with $n_1 + 1$ and $n_2 + 1$ tiers, and tier functions l_1, l_2 respectively. Given vertices $x_1 \in Q_0^{(1)}$ and $x_2 \in Q_0^{(2)}$, define $l(x_1 x_2) = l_1(x_1) + l_2(x_2)$. This defines a function $Q_0^{(1)} \times Q_0^{(2)} \rightarrow \mathbb{Z}$ with values in the interval $[0, n + n']$. For a sink $x_1 x_2$ of $Q^{(1)} \otimes Q^{(2)}$, we have $l(x_1 x_2) = 0$, for a source $(x_1 x_2)$ of $Q^{(1)} \otimes Q^{(2)}$, we have $l(x_1 x_2) = n_1 + n_2$ and given an arrow of $Q^{(1)} \otimes Q^{(2)}$, the value of l decreases by 1. This shows that we obtain a tier function for a nicely tiered quiver.

Finally, we have to note that the relations of $\Lambda_1 \otimes_k \Lambda_2$ are obtained from the relations of Λ_1 and Λ_2 and adding commutativity relations; thus, if Λ_1 and Λ_2 are defined by using only commutativity relations, the same is true for $\Lambda_1 \otimes_k \Lambda_2$.

(9.3) *Let $\Lambda_1, \dots, \Lambda_n$ be path algebras of bipartite quivers. Then $\Lambda = \Lambda_1 \otimes_k \dots \otimes_k \Lambda_n$ satisfies the conditions (P1) and (P2).*

Proof. Let us introduce some notation concerning tensor products $\Lambda = \Lambda_1 \otimes_k \dots \otimes_k \Lambda_n$, where any Λ_i is the path algebra of a finite directed quiver $Q^{(i)}$. The quiver Q of Λ is given as follows: The set of vertices is the set $Q_0^{(1)} \times \dots \times Q_0^{(n)}$, an element of this set will be denoted by $x = x_1 x_2 \dots x_n$ with $x_i \in Q_0^{(i)}$ for $1 \leq i \leq n$. Given such a vertex x , we are interested in the corresponding indecomposable projective module $P(x)$.

Let $W(x_i, y_i)$ be the set of paths in $Q^{(i)}$ starting in x_i and ending in y_i , this may be considered as a basis of $P(x_i)_{y_i}$ and therefore we may take as basis of $P(x)_y$, where x, y are vertices of Q , the product set $W(x, y) = W(x_1, y_1) \times \dots \times W(x_n, y_n)$; we call this the

path basis of $P(x)$. In particular, we see: a vertex y belongs to the support of $P(x)$ if and only if there are paths starting at x_i and ending in y_i , for $1 \leq i \leq n$.

Now assume that $Q^{(i)}$ is bipartite, thus any path in $Q^{(i)}$ is of length at most 1, thus either a vertex or an arrow. We want to describe the representation ${}_2P(x)$ for any vertex $x = x_1 \dots x_n$ of Q . Note that the support quiver of ${}_2P(x)$ will again be bipartite. We can assume that t of the vertices x_i are sources, and the remaining ones are sinks. Thus, up to a permutation we can assume that $x = x_1 \dots x_n$ with sources x_i for $1 \leq j \leq t$ and sinks $x_j = z_j$ for $t + 1 \leq j \leq n$. The support S of the socle of $P(x)$ consists of the vertices $z = z_1 \dots z_n$ where z_i is a sink in the quiver $Q^{(i)}$ such that there is a path from x_i to z_i , for any $1 \leq i \leq t$.

Given an n -tuple $u_1 u_2 \dots u_n$ where the u_i are elements of some sets (say of vertices or arrows of some quivers), and v_j is a further element, then we denote by $u[v_j = u_1 \dots u_{j-1} v_j u_{j+1} \dots u_n$ the element obtained from u by replacing its entry at the position j by v_j .

Using this notation, the vertices in the support of ${}_2P(x)$ with tier number 1 are of the form $y = z[x_j$ and the arrows of the support are of the form $z[\alpha_j$, always with $z \in S$, and with arrows $\alpha_j: x_j \rightarrow z_j$, and $1 \leq j \leq t$.

If we are interested in the structure of $P(x)$, we may assume that all the vertices x_j are sources, thus that $t = n$ (namely, if for example x_n is a sink, then $P(x_n)$ is one-dimensional and thus $P(x) = P(x_1 \dots x_{n-1}) \otimes_k P(x_n)$ can be identified with the $(\Lambda_1 \otimes_k \dots \otimes_k \Lambda_{n-1})$ -module $P(x_1 \dots x_{n-1})$).

Given a vertex x of Q , we may look at the coefficient quiver $\Theta(x)$ of $P(x)$ with respect to its path basis (for the definition, see [R2]). If we look at our example of the tensor product of two copies of the Kronecker algebra, and consider the unique source $x = x_1 x_2$ of Q , then the coefficient quiver $\Theta(x)$ of $P(x)$ with respect to the path basis looks as shown on the right:

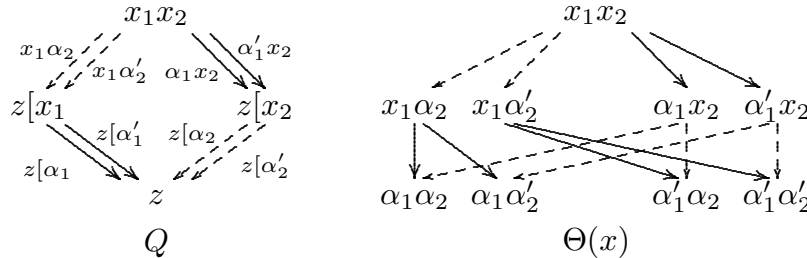

On the left, we present again the quiver of $Q = Q^{(1)} \otimes Q^{(2)}$, but now using the notation $z[?$ for the vertices with tier number 1 as well as the arrows ending in z .

Now we are going to look at ${}_2P(x)$. Let $z \in S$ and take an arrow $\alpha_j: x_j \rightarrow z_j$, let $y = z[x_j$, this is a vertex with tier number 1. The vector spaces $P(x)_y, P(x)_z$ and the linear map $P(x)_{z[\alpha_j}$ are given as follows: Since z belongs to S , there is an arrow $x_i \rightarrow z_i$ for any i and $W(x, z)$ is a basis of $P(x)_z$ (note that here $W(x_i, z_i)$ is the set of arrows $x_i \rightarrow z_i$ for all i). Similarly, for $y = z[x_j$, the space $P(x)_y$ has as a basis the set of elements of the form $\alpha[x_j$ with $\alpha \in W(x, z)$, and the linear map $z[\alpha_j: P(x)_y \rightarrow P(y)_z$ sends $\alpha[x_j$ to $\alpha[\alpha_j$.

In the coefficient quiver ${}_2\Theta(x)$ of ${}_2P(x)$, any sink α is the end point of precisely n arrows, namely the arrows labeled $z[\alpha_j: z[x_j] \rightarrow z$, where $\alpha_j \in W(x_j, z_j)$. It follows that the one-dimensional vector space $k\alpha$ generated by α is the intersection of the images of the maps

$$k\alpha = \bigcap_{j=1}^n \text{Im} (z[\alpha_j: P(x)_{z[x_j]} \rightarrow P(x)_z).$$

As a consequence, any endomorphism of ${}_2P(x)$ will map the element α of $P(x)_z$ onto a multiple of α .

We claim that *the coefficient quiver ${}_2\Theta(x)$ of ${}_2P(x)$ with respect to the path basis is connected*. Namely, given a sink $\alpha = \alpha_1 \cdots \alpha_n$ of ${}_2\Theta(x)$, and any arrow $\alpha'_j: x_j \rightarrow z'_j$ in $Q^{(j)}$ different from α_j , there is a path of length 2 in ${}_2\Theta(x)$ starting in α and ending in $\alpha[\alpha'_j]$, namely

$$\begin{array}{ccc} & \alpha[x_j] & \\ & \swarrow \quad \searrow & \\ \alpha & & \alpha[\alpha'_j] \end{array}$$

Thus, given two sinks of ${}_2\Theta(x)$, say $\alpha = \alpha_1 \cdots \alpha_n$ and $\alpha' = \alpha'_1 \cdots \alpha'_n$, we may replace successively α_j by α'_j and obtain a path of length at most $2n$ starting in α and ending in α' .

In order to deal with the conditions (P1) and (P2), we consider maps $f: {}_2P(x) \rightarrow M$ with $M = P(x')$ for some vertex x' . Actually, the essential property of M which we will need is that all the maps used in M are injective. Thus, let \mathcal{M} be the set of Λ -modules M such that all the maps used are injective. Clearly, all the indecomposable projective Λ -modules, and even all their submodules belong to \mathcal{M} .

Consider $f: {}_2P(x) \rightarrow M$ with $M \in \mathcal{M}$. We show: *Given any arrow $\alpha[x_j] \rightarrow \alpha$ in the coefficient quiver, then $f(\alpha) = 0$ if and only if $f(\alpha[x_j]) = 0$.*

Proof: Clearly, if $f(\alpha[x_j]) = 0$, then also $f(\alpha) = 0$, since α is a multiple of $\alpha[x_j]$. Thus, conversely, let us assume that $f(\alpha) = 0$. There is the following commutative diagram

$$\begin{array}{ccc} P(x)_{z[x_j]} & \xrightarrow{f_{z[x_j]}} & M_{z[x_j]} \\ P(x)_{z[\alpha_j]} \downarrow & & \downarrow M_{z[\alpha_j]} \\ P(x)_z & \xrightarrow{f_z} & M_z, \end{array}$$

with $\alpha[x_j]$ being sent by the left vertical map to α . Since the right vertical map is injective, the vanishing of $f_z(\alpha)$ implies that also $f(\alpha[x_j]) = 0$.

As a consequence of the connectivity of the coefficient quiver of ${}_2P(x)$ we conclude: *If $f(\alpha) = 0$ for some α , then $f = 0$.*

Condition (P1). Let f be an endomorphism of ${}_2P(x)$. Assume that f is not a monomorphism. Since f maps any basis vector α of the socle of ${}_2P(x)$ onto a multiple of itself, we see that there has to be such a basis element α with $f(\alpha) = 0$. But then $f = 0$.

Condition (P2). Assume there is given a non-zero homomorphism $f: {}_2P(x) \rightarrow M$ with $M \in \mathcal{M}$. Assume that $f(P(x)_{z[x_j]}) = 0$. Of course, then also $f(P(x)_z) = 0$. Thus, it follows again that $f = 0$.

Thus we see: if there is a non-zero homomorphism $f: {}_2P(x) \rightarrow P(x')$, then all the elements $z[x_j]$ with $1 \leq j \leq t$ are in the support of $P(x')$, and therefore $x'_j = x_j$. It follows that $P(x)$ is a submodule of $P(x')$.

Remark: An alternative way for proving Theorem 9.1 is as follows. First, consider the special case where none of the quivers $Q^{(i)}$ has multiple arrows. Under this assumptions all the indecomposable projective Λ -modules are thin, thus we do not have to worry about bases. The general case can then be obtained from this special case using covering theory.

(9.4) Corollary. *Let $\Lambda_1, \dots, \Lambda_n$ be path algebras of representation-infinite bipartite quivers. The algebra $\Lambda = \Lambda_1 \otimes_k \dots \otimes_k \Lambda_n$ has representation dimension precisely $n + 2$.*

Proof. This follows directly from the inequalities 7.5 and and 9.1.

The special case of the 2-fold tensor power of the Kronecker algebra has been exhibited by Oppermann in [O2], when he considered one-point extensions of wild algebras. This example was the starting point for our investigation.

References

- [APT] Assem, I., Platzeck, M.I., Trepode, S.: On the representation dimension of tilted and lura algebras, *J. Algebra* 296 (2006), 426-439.
- [A] Auslander, M.: The representation dimension of artin algebras. Queen Mary College Mathematics Notes (1971). Republished in *Selected works of Maurice Auslander*. Amer. Math. Soc., Providence 1999.
- [AB] Auslander, M., Bridger, M.: Stable Module Theory. *Memoirs Amer. Math. Soc.* 94 (1969).
- [AR1] M. Auslander, I. Reiten: Stable equivalence of dualizing R -varieties: III. Dualizing R -varieties stably equivalent to hereditary dualizing R -varieties. *Adv. in Math.* 17 (1975), 122-142.
- [AR2] M. Auslander, I. Reiten: Stable equivalence of dualizing R -varieties: V. Artin algebras stably equivalent to hereditary algebras. *Adv. in Math.* 17 (1975), 167-195.
- [Bs] Bass, H.: Finitistic dimension and homological generalization of semiprimary rings. *Trans Amer. Math. Soc.* 95 (1960), 466-488.
- [Bt] Bautista, R.: On algebras of strongly unbounded representation type. *Comment. Math. Helv.* 60 (1985), 392-399.
- [Bi] BIREP-Workshop 2008: The Representation Dimension of Artin Algebras. <http://www.math.uni-bielefeld.de/~sek/2008/>
- [Bo] Bongartz, K.: Indecomposables are standard. *Comment. Math. Helv.* 60 (1985), 400-410.
- [Bo2] Bongartz, K.: Indecomposables live in all smaller lengths. Preprint. arXiv:0904.4609
- [CE] Cartan, H., Eilenberg, S.: *Homological Algebra*. Princeton University Press, (1956).
- [CP] F. Coelho, M. I. Platzeck: On the representation dimension of some classes of algebras. *J. Algebra* 275 (2004), 615-628.

- [EHIS] K. Erdmann, Th. Holm, O. Iyama, J. Schröer: Radical embeddings and representation dimension. *Adv. in Math.* 185 (2004), 159-177.
- [G] Gabriel, P.: The universal cover of a representation-finite algebra. In: *Representations of Algebras*. Springer LNM 903 (1981), 68-105.
- [HU] Happel, D., Unger, L.: Representation dimension and tilting. *Journal Pure Appl. Algebra* 215 (2011), 2315-2321.
- [IT] Igusa, K., Todorov, G.: On the finitistic global dimension conjecture for Artin algebras. *Fields Institute Communications*, vol. 45, 2005, 201-204.
- [I] Iyama, O.: Finiteness of representation dimension. *Proc. Amer. Math. Soc.* 131 (2003), 1011-1014.
- [J] Jans, J.P.: *Rings and Homology*. Holt, Rinehart and Winston. New York 1964.
- [L] Leszczyński, Z.: On the representation type of tensor product algebras, *Fund. Math.* 144 (1994), 143-161.
- [LS] Leszczyński, Z., Skowroński, A.: Tame tensor products of algebras, *Colloq. Math.* 98 (2003), 125-145.
- [O1] Oppermann, S.: Lower bounds for Auslander's representation dimension *Duke Math. J.* 148 (2009), 211-249.
- [O2] Oppermann, S.: Wild algebras have one-point extensions of representation dimension at least four *J. Pure Appl. Algebra* 213 (2009), no. 10, 1945-1960.
- [O3] Oppermann, S.; Representation dimension of quasi-tilted algebras *J. Lond. Math. Soc.* (2) 81 (2010), 435-456.
- [O4] Oppermann, S.: Private communication, May 6, 2008.
- [R1] Ringel, C. M.: Tame algebras and integral quadratic forms. Springer LNM 1099.
- [R2] Ringel, C.M.: Exceptional modules are tree modules. *Lin. Alg. Appl.* 275-276 (1998) 471-493
- [R3] Ringel, C.M.: The torsionless modules of an artin algebra. Selected Topics WS 2007/8. <http://www.math.uni-bielefeld.de/~ringel/opus/torsionless.pdf>
- [R4] Ringel, C.M.: Iyama's finiteness theorem via strongly quasi-hereditary algebras. *Journal of Pure and Applied Algebra* 214 (2010) 1687-1692.
- [R5] Ringel, C.M.: Indecomposables live in all smaller lengths. *Bulletin of the London Mathematical Society* 2011; doi: 10.1112/blms/bdq128
- [R6] Ringel, C.M.: The minimal representation-infinite algebras which are special biserial. To appear in: *Representations of Algebras and Related Topics*, EMS Series of Congress Reports, European Math. Soc. Publ. House, Zürich, 2011
- [Rq] Rouquier, R.: Representation dimension of exterior algebras, *Inventiones Math.* 165 (2006), 357-367.
- [X1] Xi, Ch.: On the representation dimension of finite dimensional algebras. *Journal of Algebra*, 226, (2000), 332-346.
- [X2] Xi, Ch.: Representation dimension and quasi-hereditary algebras. *Advances in Math.* 168 (2002), 193-212.

Fakultät für Mathematik, Universität Bielefeld
 POBox 100 131,
 D-33 501 Bielefeld, Germany
 e-mail: ringel@math.uni-bielefeld.de