

Syntactic Relations

John Bowers

Preface

The most salutary effect of Chomsky's Minimalist Program is that it has forced linguists to examine critically the primitive concepts and operations of syntax, in order to eliminate anything that cannot be shown to be absolutely essential. Minimally, there must be two interface levels, SEM and PHON, whose representations are "legible" to (can be "read" by) the conceptual-intentional (CI) systems and the sensorimotor (SM) systems, respectively. In addition there must be a lexicon, consisting of a finite set of words or lexical items (LIs), from which an infinite set of sentences can be constructed. The fundamental minimalist question is: what else is needed?

Chomsky himself has already gone quite far in the direction of simplifying syntax, including eliminating X-bar theory and the levels of D-structure and S-structure entirely, as well as reducing movement rules to a combination of the more primitive operations of Copy and Merge. What remain are the operations Merge and Agree and the levels of LF and PF. Merge takes as input two syntactic objects, each of which is either an LI or a previously formed syntactic object and forms an unordered set consisting of those two objects, along with a label, which is either an LI that is one of the inputs to the operation or an LI that has previously been assigned to one of the inputs to the operation. The end result of a derivation, consisting of sequence of such operations, is, on the one hand, an LF representation from which all "uninterpretable" features have been eliminated and which obeys all local economy conditions and, on the other hand, a PF

representation formed by applying “Spell-Out”, which strips away the phonetic properties of LIs.

I argue in this work that even a system this pared-down is still far too rich. I will show that given the most basic legibility conditions at SEM and PHON, the only operation needed in the syntax is “Form Relation” (FormRel), which combines pairs of LIs, or features of LIs, and forms ordered pairs in accordance with specific properties of those LIs. There is a very small set of ordered pairs that constitute the fundamental *relations* (in the mathematical sense) of natural language syntax. I assume in this work just four basic relations: selection, subcategorization, modification, and agreement. I show in addition that each time an ordered pair is formed, there is an immediate reflex in both PHON and SEM (“Immediate Spell-Out” and “Immediate Interpretation,” respectively). Given these assumptions, I then show that the notions of constituent structure and movement are simply artifacts of the fundamental legibility conditions that hold at SEM and PHON, together with a small number of computational principles that either limit the search space of FormRel or limit the possible outputs of Spell-Out and Interpretation.

Of course neither the idea that the primitives of syntactic theory should be relations rather than constituents nor the idea that Spell-Out and Interpretation should be immediate are totally new. Various versions of the former have been proposed in frameworks as diverse as Relational Grammar, Dependency Grammar, and Word Grammar. An early version of Immediate Spell-Out was proposed by Bresnan (19). Various different versions of Immediate Interpretation are assumed in the earliest work in transformational-generative grammar (Chomsky 1955, 1957), in Montague Grammar,

in later transformational work such as Bowers 1973, 1976, Bowers and Reichenbach 1976, and, more recently, in Epstein et al (1998). The theory proposed in this work, while drawing to some extent on all of these traditions, derives its immediate impetus from Chris Collins' important paper "Eliminating Labels." Collins argues that given a principle of lexical access (Chomsky 2000) that he calls "The Locus Principle" (LP), the labels in the theory of Bare Phrase Structure can be eliminated entirely, leaving bare Merge as the only operation of syntax apart from Agree. From there it is a short step, as shown in Bowers 2000 and Collins and Ura 2001, to the idea of eliminating phrase structure altogether and, as shown in Bowers 2000, to eliminating all copy operations from the syntax as well.¹ In this work I attempt to show not only that a relational theory of syntax is *possible* but that it comes very close to being the optimal solution to the problem of relating the representations of SEM and PHON, given the most basic legibility conditions imposed on SEM and PHON by CI and SM, respectively, and assuming that the only place that semantic, syntactic and phonetic information is stored is in a finite set of lexical items (LIs) contained in the lexicon (Lex) of each language.

In Chapter 1, I outline the basic assumptions of the theory in relatively informal fashion. In Chapter 2, I discuss in greater detail the fundamental syntactic relations of selection, subcategorization and modification, showing that they are both necessary and sufficient in order to bridge the gap between the function-argument structures required for legibility at SEM and the linearly ordered strings of phonetic forms of LIs required for legibility at PHON. In Chapter 3, I take up the agreement relation, arguing that it

¹ The possibility of eliminating phrase structure was first mentioned by Chris Collins in early 2000, during one of our many discussions of his paper. The proposals in Bowers 2000 and in the present work and those

exists because it is a near optimal solution to the problem of relating certain “long-distance” properties of SEM to the fundamental morphophonological properties of PHON. I then show how the agreement relation combines with the more fundamental relations discussed in Chapter 2 to characterize correctly a wide range of syntactic constructions of the sort universally found in natural language. In this chapter I rely crucially on a relational version of the proposals in Bowers 2002. In Chapter 4, I extend and combine the results of the preceding chapters to deal with raising and obligatory control constructions, showing how the possibility of “displacements” of indefinite length can be derived from basic principles. In the course of this discussion, I also show that Immediate Interpretation is the null hypothesis, only to be given up in the face of strong arguments to the contrary, as argued in earlier work of mine (Bowers 1973, Bowers and Reichenbach 1976) and in Bowers (forthcoming). Finally, in Chapter 5, I deal somewhat sketchily with operator constructions such as *wh*-questions, showing how their basic properties can be derived by small extensions of the principles already in place, together with the legibility conditions for operator-variable structures imposed on SEM. In the course of developing these arguments, I entertain various possible ways of constraining the computational mechanism of the syntax, as well as the operation of Spell-Out and Interpretation. I conclude finally that the only purely syntactic constraint that is needed, apart from LP, is a condition limiting the search space of FormRel which I term the “Accessibility Condition.”

in Collins and Ura 2001, though similar in many ways, were developed independently of one another.

I would like to thank Neil Smith for reading this manuscript and suggesting a number of improvements. I would also like to thank audiences at lectures at University College London and the University of Edinburgh for their comments and suggestions.

December, 2001

London, England

Chapter 1

Introduction and Overview

Virtually all modern theories of syntax are based in one way or another on the two fundamental notions of constituent structure and movement. So, for example, the syntax of a sentence such as *what will John do?* would standardly be derived roughly as shown below:

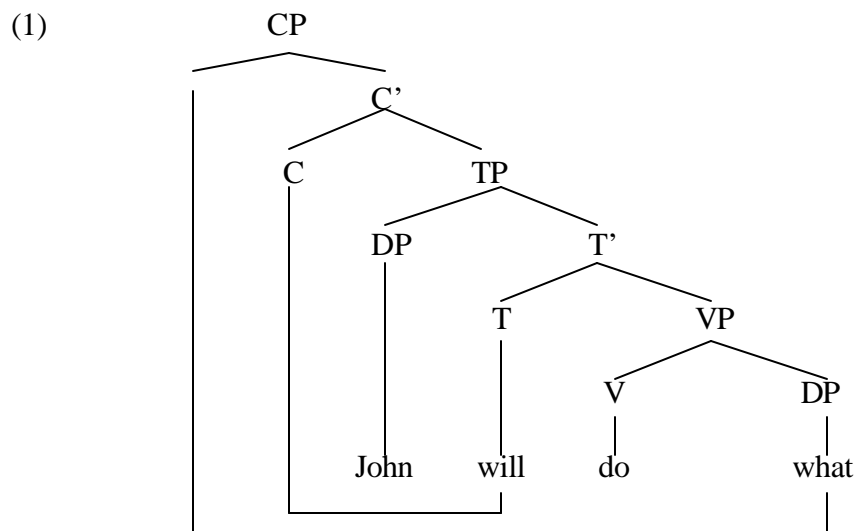

In a representation of this sort the subtrees $[_{VP} [V \text{ do}] [_{DP} \text{ what}]]$, $[[[_{T'} [T \text{ will}] [_{VP} [V \text{ do}]] [_{DP} \text{ what}]]]$, etc. represent *labeled constituents*, projected in standard X'-theory from basic lexical categories such as V, N, D, T, C, etc., while the arrows represent *movement* or *displacement* operations that create a copy of a constituent and merge it in an

appropriate place in constituent structure. The questions that I will be concerned with in this work are the following. Where do these notions come from? How do they arise in the cognitive system of the human brain? Are these notions irreducible primitives? Or could they be derived from more fundamental concepts? And if the latter is true, how?

Let's start by considering some very basic properties of the human linguistic mechanism. Reduced to bare essentials, language is a cognitive system that stores information about sound and meaning. The basic units of the system are words or lexical items (LIs) stored in a lexicon (Lex), each of which consists of a set of features F (linguistic properties). Minimally, there must be two interface levels SEM and PHON that provide information to the conceptual-intentional systems (CI) and the sensorimotor systems (SM), respectively. Then a language L must provide a recursive definition of a set of pairs of expressions $Exp = \langle SEM, PHON \rangle$, based on the semantic and phonetic information contained in the LIs in Lex.

How did a system of this sort come into existence? Chomsky (2000, 2001a) speculates that the strongest possible hypothesis would be the following:

(2) Strongest Minimalist Hypothesis:

Language is an optimal solution to legibility conditions.

Here the term 'legibility conditions' refers simply to the conditions that must be met in order for other systems of the mind/brain to access the Exp of L , i.e. to "read" them and use them as "instructions" for thought and action. Since the CI systems and the SM systems are independent of L , it makes sense to ask how well L satisfies the design

specifications they impose. If the language system satisfies the legibility conditions in an optimal way and also satisfies all other empirical conditions, e.g. acquisition, processing, neurology, etc., then it could be said to be a perfect solution to minimal design specifications.

1 Syntactic Relations

Putting aside the question of whether the language system is perfect or not, let's focus on a more basic question: what is the minimal apparatus that must be assumed in order to derive the fundamental syntactic notions of constituent structure and movement from the legibility conditions imposed on PHON and SEM? I will show that given a very small set of *syntactic relations*, together with an operation *Form Relation* that operates in sequential fashion to form networks of relations based on the properties of specific LIs, the notions of constituent structure and movement can be derived from one of the most basic properties of PHON, namely, the requirement that lexical items be linearly ordered in a way that reliably and consistently reflects the fundamental syntactic relations between words. I will then go on to show that other syntactic relations such as Agreement and Case-marking fall out from the most minimal assumptions about morphology. Finally, I will show—albeit in a somewhat sketchier fashion—that the very same set of syntactic relations is the minimum apparatus necessary to support semantic representations of the sort required by the CI systems.

Before sketching out the form of the theory I intend to propose, some terminological clarifications are necessary. In mathematical parlance, a *relation* is

simply a set of ordered pairs. An *ordered pair* in turn is standardly defined in terms of sets as follows:

- (3) An *ordered pair* with a as *first coordinate* and b as *second coordinate*, denoted (a, b) is equal to the set $\{\{a\}, \{a, b\}\}$.

Once order has been defined in terms of the more primitive notion of a set, it can be used as if were a primitive without having to go back to the definition at every point. Given any two sets A and B , the *Cartesian product of A and B* , denoted $A \times B$ is defined as follows:

$$(4) A \times B =_{\text{def}} \{(x, y) \mid x \in A \wedge y \in B\}$$

A (binary) relation R that is a subset of $A \times B$ is said to be a relation *from A to B* , while one that is a subset of $A \times A$ is said to be a relation *in A* . I use the term ‘relation’ in this work in a systematically ambiguous fashion to refer either to an ordered pair (α, β) of LIs α and β or to one of a small set of binary relations in L (in the mathematical sense), where L is the set of LIs of a given language.

I start out by assuming just the following two basic syntactic relations in L :

- (5) a. $R_{\text{Sub}}(\alpha, \beta)$: α *subcategorizes* β .
 b. $R_{\text{Sel}}(\alpha, \beta)$: α *selects* β .

A subcategorization or selection relation $R(\alpha, \beta)$ holds between two LIs just in case the LI α in the first coordinate requires that the LI β in the second coordinate have some specified set of syntactic properties. Following standard practice, I assume that these properties are specified in the lexical entry of the LI in the first coordinate by means of subcategorization and selection *features* of the form $[__C]$, where C is a categorial feature, some combination of categorial and other syntactic features, or a specific LI of some category. For example, a verb that is subcategorized for an object DP has the feature $[__D]$; a verb such as *rely* has the selection feature $[__on_p]$; a verb that selects a finite complement has the selection feature $[__that_C]$; the complementizer *for* has a selection feature $[__to_T]$; etc. Following Collins (2003), I assume that there are no category labels apart from the category features associated with LIs, so that the relations in (5) refer only to category features and other features associated with LIs. Thus there are no *labels* associated with constituents, as there are in the standard minimalist framework. In the present framework, of course, this follows from the more fundamental fact that there are simply no constituents in syntax with which labels *could* be associated.

For the moment, I will distinguish the subcategorization and selection relations in purely syntactic terms. A syntactic relation $R(\alpha, \beta)$ is an instance of subcategorization if β belongs to the category D; otherwise it is an instance of selection. As will be seen in Chapter 2, subcategorization is distinguished from selection by semantic properties as well. I defer until then the task of showing in more formal terms how these two basic relations arise out of the legibility conditions at SEM. Informally, the subcategorization relation holds between two LIs when the second coordinate of the relation is a basic

entity expression, hence an *argument* of the first coordinate.² The selection relation holds between two LIs when the second coordinate of the relation is a property expression or a proposition that combines with the first coordinate to form a *complex predicate*. The intuition lying behind the distinction between subcategorization and selection is the familiar one that nominal expressions are necessary to “complete the meaning” of a head, whereas other kinds of expressions “extend the meaning” of the head.

2 FormRel and the Locus Principle

I assume, as mentioned above, that there is just one basic operation in narrow syntax (NS), which I shall refer to as *Form Relation* (*FormRel*, for short).³ FormRel is a binary operation that applies to LIs α and β and forms an ordered pair (α, β) . Given this operation, a network of syntactic relations is built up in the following way. First, an array A of LIs is chosen from Lex. Second, FormRel applies successively to pairs of LIs, selected from A and from previously formed ordered pairs, continuing until all the selection and subcategorization features of every LI are satisfied and none are left unsatisfied. The derivation is regulated by the following computational principle, a slightly modified version of Collins’ (2003) *Locus Principle*:

² NB: I am not using the term ‘argument’ here in the Fregean sense of an expression that is required in order to ‘saturate’ an incomplete expression, or in more modern terms, to assign a value to a function. In the semantic sense of the term, both subcategorized and selected elements are arguments. See note 2. See also Chapter 3, for further discussion.

³ This term is first used in Bowers (2000). Collins and Ura (2001) use the term *Establish Rel* for the same operation.

(6) The Locus Principle (LP):

Suppose a LI λ , called the Locus, containing unsatisfied selection and subcategorization features, is selected from a lexical array. Then all the subcategorization conditions and selectional requirements of λ must be satisfied before a new LI can be selected as the Locus.

A LI all of whose subcategorization conditions and selectors have been satisfied is said to be *saturated*; if any of them have not been satisfied, it is said to be *unsaturated*.⁴ The Locus Principle thus rules out the possibility of a LI α forming a relation with an unsaturated LI β . As shown in Bowers 2000 and Collins and Ura 2001, this in turn imposes an inherent order on the process of forming a network of relations between LIs. Thus consider the phrase *read the books*. The LP requires that the relation $R_{\text{Sel}}(\text{the}, \text{books})$ be established before the relation $R_{\text{Sub}}(\text{read}, \text{the})$. If the latter was formed first, the LP would be violated, since *the* would be unsaturated at that point.

It is important to note that there are no constituents in a theory of this sort. In the example just discussed, there is no constituent [the book] in NS, nor is there one of the form [read [the books]] (with or without labels). Instead, there are simply two relations (read, the) and (the, books). Though there is a superficial similarity between a theory based purely on relations and one that incorporates the operation Merge or its equivalent, due to the fact that both involve the construction of sets, the operation Merge in fact goes

⁴ Note again that the terms ‘saturated’ and ‘unsaturated’, as used here, are purely syntactic. Hence their use is related only indirectly, if at all, to the semantic (Fregean) sense of these terms.

far beyond what is involved in a relational theory. In the example at hand, the output of the Merge operation would be a new syntactic object of the form: {read, {the, books}}. Despite the fact that the outputs of successive applications of Merge are only unordered sets, each operation results in a new syntactic object which incorporates the results of all the preceding operations. Hence it is clearly a theory that incorporates a notion of constituent structure. In a relational theory, on the other hand, no new syntactic objects of this sort are produced. Instead, there are just the two ordered pairs (read, the) and (the, books).⁵

3 Linearization

Suppose a network of relations has been established in the manner just described. In order to be utilizable by SM, the absolute minimum that must be done is to arrange the phonological forms of the LIs in the network in linear order. Hence there must be a function F_L that systematically maps relations onto linearly ordered strings of phonetic representations of words. Before discussing the operation of F_L , however, it is first necessary to introduce some notational conventions. Whenever it is clear from the context, I shall use standard orthographic forms such as ‘the’, ‘books’, ‘read’, etc. in a systematically ambiguous fashion to refer either to the phonetic form of an LI or to the entire LI, consisting of a semantic representation, a set of syntactic features, and a phonetic representation. Where it is necessary in the text to distinguish explicitly the

⁵ As discussed above, the two relations (read, the) and (the, books) are reducible, by definition, to the sets {{read}, {read, the}} and {{the}, {the, books}}. However, neither of these sets incorporates the results of

name of an LI from its phonetic form, I will do so by italicizing the orthographic form in the former case and underlining it in the latter case. Thus *the* is the name of the LI: [the', D, the], while the represents the phonetic form of *the*. In addition, I represent the linear ordering relation by means of a dash '-':

Suppose α and β are LIs and the ordered pair (α, β) is a member of the selection relation R_{Sel} . The linearization function F_L operates on $R_{Sel}(\alpha, \beta)$ as follows:

$$(7) F_L(R_{Sel}(\alpha, \beta)) = \alpha-\beta$$

F_L is thus a very simple and general function which ensures that the phonetic form of the first coordinate of a subcategorization relation precedes the phonetic form of the second coordinate.

Consider next the subcategorization relation. Given an ordered pair $(\alpha, \beta) \in R_{Sub}$, F_L operates in English as follows:

$$(8) F_L(R_{Sub}(\alpha, \beta)) = \beta-\alpha$$

The effect of the linearization function in the case of subcategorization is just the opposite of its effect in the case of selection.⁶

previous applications of FormRel.

⁶ In "head-final" languages such as Japanese, in contrast, F_L arguably operates in the same direction for selection as it does for subcategorization. If the speculations in Kayne (1994) turn out to be correct, then the output of F_L is the same for all human languages.

Let us assume now that the linearization function operates each time FormRel creates an ordered pair, an assumption I shall term *Immediate Spell-Out*.⁷ Suppose a lexical item λ is picked from the lexical array A to serve as the Locus. FormRel then starts forming ordered pairs between λ and other lexical items in the array. Each time a binary (subcategorization or selection) relation is formed, the linearization function creates a corresponding phonetic form by arranging the phonetic forms of the two lexical items in a specified order.

To see how F_L works, let's start by choosing the lexical items *read*, *the*, and *book*. Assuming, as before, that *the* selects nouns and *read* subcategorizes determiners, the two relations (the, books) and (read, the) can be formed. As discussed previously, the LP requires that they be formed in that order. The relation (read, the) couldn't be formed first, because *the* would be unsaturated at that point. The derivation will thus proceed as follows. I show the output of FormRel, represented as ordered pairs, on the left and the output of F_L , represented as linearly ordered phonetic forms, on the right:

(9) 1. Select *the*, *books* from A: Locus: *the* (unsaturated); *books* is saturated.

FormRel(the, books)=(the, books) $F_L((the, books))= the-books$

2. Select *read* from A; select *the* from (the, books) formed at step 1:

⁷ Immediate Spell-Out is equivalent to what Collins and Ura (2001) term "incremental Spell-Out at the relation level." As Collins and Ura note, there are other possible theories of incremental Spell-Out, e.g. Spell-Out at the locus level, Spell-Out at the phase level, etc. They argue, as I do, for the first of these, while Chomsky (2000, 2001a) argues for the last. In the absence of strong arguments to the contrary, Immediate Spell-Out would seem to be the null hypothesis.

Locus: *read* (unsaturated); *the* is saturated.

FormRel(read, the)=(read, the) $F_L((\text{read}, \text{the})) = \text{the-books-read}$

At step 1, we start by choosing as Locus the lexical item *the*, which selects the noun *books*. This is the simplest possible case, where both coordinates of the relation are LIs selected from the lexical array. Therefore, by (7), the output of F_L is the string the-books. Notice that the Locus *the* has been saturated at this point. To continue the derivation, a new Locus, the lexical item *read*, is selected from the lexical array, together with the (now saturated) LI *the* from the previously formed relation (the, books). Applying FormRel to this pair of LIs yields the ordered pair (read, the), an instance of the relation R_{Sub} . The linearization function dictates that the must precede read. At this juncture, two questions arise. First, why does F_L require that the phonetic form of the LI *read* follow the entire string the-books, rather than immediately following the phonetic form of the single word the, as (8) would seem to require? (Note that if the saturated LI *it* had been selected, then (8) would correctly produce the string it-read.) Second, why does F_L in 2. produce the-books-read, rather than the-read-books?

The answer to the first question lies in the incremental nature of the linearization process. At each step of the derivation an ordered pair is produced, accompanied by a linearly ordered string of phonetic forms of LIs. If one of the LI's of this ordered pair is chosen as partial input to a later application of FormRel, then the entire string that accompanies the ordered pair constitutes part of the input to the next step in the derivation. In the example above, because the saturated LI *the* is selected from the ordered pair (the, books) as partial input to the next application of FormRel, the entire

string the-books produced by F_L at that stage of the derivation must constitute part of the input to the next application of F_L . To answer the second question, I propose an economy principle, which I shall term *Conservation of Order* (CO), that dictates that once a string is formed at a given step of the derivation, it cannot be disrupted by an application of F_L at a later step of the derivation. It follows that the phonetic form read, rather than immediately following the phonetic form the, must instead follow the entire string the-books that was formed at the previous step of the derivation, yielding the string the-books-read. The output the-read-books would violate CO.

Given these assumptions, it is evident that the substring the-books *appears to act like a constituent* with respect to the phonetic form of the verb *read*, even though no operation has at any point constructed such an object, either in NS or in PHON. The constituent-like behavior of the string the-books simply falls out as a consequence of the way that the linearization function operates, together with the principles of Immediate Spell-Out, LP and CO. This shows that constituent structure can in principle be derived from the more basic notion of a syntactic relation, given the legibility conditions imposed by PHON, together with the computational principles discussed.

4 Verb Movement

Notice, however, that the correct English word order for a transitive phrase such as *read the books* has yet to be produced. At the same time, this phrase needs a subject in order to form a complete proposition, reflecting the universal requirement that sentences have both a subject and a predicate. Following Bowers (1993, 2001a, 2002), I assume that

there is a category ‘Pr’ which usually has no phonetic form in the lexicon in English.

Following Chomsky (1994, 1995), I use the symbol ν to refer to this LI. The LI ν selects V and subcategorizes a D which functions as its external argument. Therefore the derivation (9) continues as follows, assuming that the LI ν is contained in the lexical array:⁸

(10) 3. (ν , read) ?-the-books-read

There is a problem at this point, however, because the LI ν lacks a phonetic form that is “readable” by SM. Let us suppose that in this situation, the linearization function F_L is required to provide ν with an occurrence (or token) of the phonetic form of the second coordinate β of the relation $R_{Sel}(\nu, \beta)$, thus rendering the representation at PHON legible to SM. I assume a general principle of phonetic interpretation according to which only the last occurrence of the phonetic form of an LI is actually pronounced.⁹ In the interests of perspicuity, I enclose every occurrence of a phonetic form but the last one in angled brackets in representations at PHON. The operation of F_L in this case may then be stated quite generally as follows:

(11) $F_L(R_{Sel}(\alpha, \beta)) = \beta - \langle \beta \rangle$, where α has no phonetic interpretation.

⁸ Henceforth I simplify the statement of derivations by omitting everything except the outputs of FormRel (on the left) and F_L (on the right).

⁹ Alternatively, it could be stipulated that each time a new token of a LI (or substring of LIs) is created, the previous token is replaced with the null string e .

Hence step 3. of the derivation now looks as shown in 3.', followed by formation of the relations (the, boys) and (v, the), in order to satisfy the subcategorization condition of *v*:¹⁰

- (12) 3.' (v, read) read-the-books-<read>
4. (the, boys) the-boys
5. (v, the) the-boys-read-the-books-<read>

At step 3.' a selection relation between *v* and *read* is formed. Therefore, by (7) the output of step 2., namely, the string the books read, must be placed to the right of *v*. At the same time, (11) provides a new token of read in the position that should be occupied by the phonetic form of *v*. The result of these two operations is the string shown on the right in 3.' Thus the apparent "movement" or "displacement" of the verb *read* to the left of the object DP *the books* is really just a consequence of the fact that the linearization function operates in such a way as to ensure that representations at PHON satisfy the legibility conditions imposed by SM. Finally, at step 5. the string the boys, the output of F_L at step 4., is placed to the left of the string read the books <read>, the output of F_L at step 3.', resulting in the correct phonetic form: the boys read the books <read>.

5 Constituent Movement

¹⁰ It might be wondered what prevents operations 3.' and 5. in (13) from applying in the opposite order. It will be shown in Chapter 3 that this is ruled out by a purely semantic constraint.

Consider next an intransitive sentence such as *an explosion occurred*. There is a mass of linguistic evidence supporting the claim that the subject of an unaccusative verb such as *occur* is subcategorized by the verb and has an argument relation to it.

Hence the derivation of such a sentence must start out as follows:

- (13) 1. (an, explosion) an-explosion
2. (occur, an) an-explosion-occur

Let us assume, as before, that v has a subcategorization feature requiring it to form a relation with a LI of category D. In this case, however, we shall assume that there is no semantic function-argument relation between v and D. (In the terminology of Chomsky 2000, 2001a, v has an *uninterpretable* subcategorization feature.) Let us assume further the following relational version of the θ -Criterion:

- (14) Every (non-expletive) subcategorized LI of category D must be interpreted as an argument at SEM and every argument required at SEM must be realized as a (non-expletive) subcategorized LI of category D.¹¹

¹¹ The stipulation that (14) applies only to subcategorized LIs of category leaves open the possibility that DPs can function as predicate nominals, see Bowers 1993, 2001a, for discussion. Note also that (14), unlike the standard version of the θ -Criterion, does not require that a D be interpreted as a *unique* argument at SEM. The reason for this will become apparent in Chapter 4.

Now suppose that the array contains another determiner *an* and a noun such as *accident*, with which *an* may form a selection relation. There is nothing to prevent the subcategorization condition of ν from being satisfied by forming a relation with the D *an* of *an accident*. However, there is no way for *an* to be interpreted as an argument, since ν , by hypothesis, does not require a semantic argument in this instance. Hence a sentence such as **an accident occurred an explosion* is uninterpretable. (As will be shown in Chapter 3, it is syntactically ill-formed as well.) It follows that the only possible way for the subcategorization condition of ν to be met, while at the same time respecting the θ -Criterion, is for it to form a relation with a D *that has already been interpreted as an argument*. In this instance, the only such D that is available is the LI *an* that selected *explosion* at step 1. of the derivation in (13). By (8), the phonetic form an-explosion should precede the token of occur that was substituted for ν . However, the phonetic form an-explosion was required to follow this token of occur at step 3. of the derivation. A given phonetic form α cannot both precede and follow another phonetic form β . The only way to escape this contradiction is for F_L to provide a second occurrence (or token) of the phonetic form an-explosion, which can then be ordered to the left of occur.¹² The derivation thus continues as follows:

(15) 3. (v, occur) occur-an-explosion-<occur>

¹² Representations at PHON are therefore *strings*, in the mathematical sense, rather than a totally ordered set (Wall 1972: 164-166). A string is a linear ordering of the *occurrences* or *tokens* of the members of a set, whereas in a totally ordered set each member occurs only once and occupies a unique place in the ordering.

4. (v, an) an-explosion-occur-<an explosion>-<occur>

At step 4. of the derivation, a new occurrence of the substring an explosion, the output of step 1., must be placed to the left of the output of step 3. By the general principle of phonetic interpretation mentioned earlier, the original occurrence of an explosion that follows occur is unpronounced. Hence the apparent “movement” of the “constituent” an explosion, can be explained once again as an artifact of the legibility conditions, together with general computational constraints on the application of FormRel and FL. Note, however, that the appearance of constituent movement, in contrast to head movement, is forced by a combination of legibility conditions at PHON and SEM.

Interestingly, there is direct evidence in support of this analysis. It happens that English has a special LI belonging to the category D, the expletive *there*, which has no semantic content and is therefore inherently incapable of serving as a semantic argument. Hence an alternative way for *v* to satisfy its (uninterpretable) subcategorization feature—assuming that *there* is present in the array—is to form a relation with *there*, thus obviating the need for a second occurrence of the phonetic form of *an explosion* to precede occur in order to satisfy the legibility conditions of PHON and SEM. The result is the alternative form *there occurred an explosion*, in which the phonetic form of *an explosion* actually follows that of the verb in PHON, while the phonetic form of *there* precedes it:

(16) 4.’ (v, there) there-occur-an-explosion-<occur>

6 Morphological Marking: Case and Agreement

The absolute minimum that is necessary to map a network of syntactic relations onto a representation of PHON that is legible to SM is, as we have just seen, a function that systematically pairs syntactic relations and linear ordering relations. However, linear ordering is not the only way that relations can be made legible to SM. Another possibility is to utilize morphological properties of PHON. In fact, given a reasonably constrained notion of the morphological structures that are universally available in PHON, there are just a few logically possible ways of representing a given syntactic relation by means of morphological devices. For the purposes of this discussion, I abstract away from the difference between prefixes, suffixes and infixes and from the descriptive problems involved in dealing with ‘irregular’ or ‘suppletive’ morphology.

Now suppose that we have a syntactic relation $R(\alpha, \beta)$. There are in principle three ways that the relation between α and β might be represented morphophonologically. First, it might be required that the phonetic forms $\underline{\alpha}$ and $\underline{\beta}$ of α and β have *correlated* syntactic morphemes, M_1 and M_2 , that always mark the phonetic form of *both* coordinates of the relation, so that $\underline{\alpha} + M_1 \Leftrightarrow \underline{\beta} + M_2$, where the morphemes M_1, M_2 are in turn systematically correlated with some intrinsic syntactic property of either α or β . Second, there might be some particular morpheme M that always marks the (phonetic form of the) *second* coordinate β of the relation R . Third, there might be a particular morpheme M that always marks the *first* coordinate α of the relation. These three possible devices are exemplified in natural language by Agreement morphology, Case-marking and Applicative morphology, respectively.

The relation between a verb and its subject nominal, for example, is frequently marked by an agreement system in which specific morphological forms of the nominal correlate with specific forms of the verb. These in turn are typically a function of certain intrinsic properties of the nominal, such as Number, Gender, Noun class, etc. Many languages have similar agreement systems that mark the relation between a verb and its object nominal. However, an equally common way of distinguishing morphologically between the relation of a verb and its subject and the relation of a verb and its object is to mark the phonetic form of the object nominal with a morpheme conventionally referred to as *accusative* case and the phonetic form of the subject nominal with a morpheme conventionally referred to as *nominative* case. It is also not uncommon for Agreement morphology and Case morphology to coexist in the same language. Finally, many languages mark the relation between a verb and one of its arguments by means of an *applicative* morpheme attached to the phonetic form of the verb.¹³

Clearly, these morphological marking systems are just the logically possible methods, given the kinds of morphophonological devices available in natural language, of rendering the fundamental syntactic relations legible to SM. Even so, this does not explain why the *particular* syntactic relations subject and object, for example, are universally marked by these devices. I shall argue in Chapter 3 that which syntactic relations are morphologically marked is dictated largely by legibility conditions required by CI. It will thus turn out once again that the syntactic relations universally found in

¹³ For reasons that I do not at present understand, it seems that applicative morphology is generally used only to signal a *change in valence*. For example, if a base transitive verb is used as an unaccusative, it is often marked with a special morpheme, e.g. *-sja* in Russian (Babby 1975), *-ea* in Duala (Epée 1976). Lack of space precludes further discussion of Applicative morphology in this work.

natural language are quite narrowly determined by a combination of legibility conditions at PHON and SEM.

7 Summary

If the approach to syntax outlined briefly in the preceding sections remains viable, when worked out in greater detail and extended to a wider range of data, then we may tentatively draw the following conclusions: (1) there is no syntactic operation such as Merge that produces constituents in NS; (2) there is no syntactic operation Move that displaces or copies constituents in NS; (3) the only *purely syntactic* operation that is needed in NS is FormRel, which forms ordered pairs of lexical items; (4) subsequences of the phonetic forms of lexical items in PHON that appear to have the properties of constituents arise as an automatic consequence of the operation of the linearization function, as it attempts to meet the legibility conditions at PHON, while at the same time respecting computational principles such as LP, Immediate Spell-Out, and CO; (5) the apparent displacement of lexical items such as verbs results from the fact that the linearization function provides an LI such as v , which has no phonetic interpretation of its own, with a token of the phonetic form of the LI that it selects; (6) finally, the apparent displacement, or movement, of constituents results from the fact that an “uninterpretable” subcategorization feature (one that has no corresponding argument in SEM) associated with some LI can only be satisfied by establishing a relation with the nearest LI that has already been interpreted as an argument at SEM by virtue of a relation with an LI that has an “interpretable” subcategorization feature. The principles governing the application of

the linearization function F_L thus ensure that an occurrence of the phonetic form of the argument LI (along with all its dependents) shows up at PHON in the position where the uninterpretable subcategorization feature requires there to be phonetic material. I elaborate on these claims in the chapters that follow.

Chapter 2

Fundamental Syntactic Relations

In this chapter I discuss in more detail the three fundamental syntactic relations *subcategorization* (R_{Sub}), *selection* (R_{Sel}) and *modification* (R_{Mod}). I shall argue that these relations universally correlate with *linear order* at PHON and with *function-argument* structure at SEM. I call them fundamental because they relate, on the one hand, to the absolute minimum required to make representations at PHON legible to SM, namely, linear order, and on the other hand, to the absolute minimum required to make representations at SEM legible to CI, namely, function-argument structure. Without these fundamental syntactic relations, together with the operation FormRel, the computational system of natural language would be unable to meet the most elementary legibility conditions at both PHON and SEM, while at the same time producing an infinite set of pairs $\langle \text{SEM}, \text{PHON} \rangle$.

1 Subcategorization and Selection

One of the most basic relations in syntax is subcategorization. A transitive verb is said to subcategorize a DP, a ditransitive verb is said to subcategorize two DPs, and so forth.

But what is the nature of the relation between a verb and an element it subcategorizes, say, the verb *kiss* and the determiner *him* in the sentence *she kissed him*? Clearly, it is an

asymmetrical relation, because the determiner is required to occur with the verb, not vice-versa. This is reflected in the common practice of representing subcategorization conditions by means of a feature of the form [$___D$], associated with the verb.

(Following Chomsky (2000), we may refer to such a feature as a *selector*.) This feature can be construed as an instruction to *FormRel* to establish a relation between the verb *kiss* and an LI of category D such as *him*, the first coordinate of which is *kiss*. The result of this operation is the ordered pair (kiss, him). More generally, the relation between any transitive verb and the determiner it is subcategorized for can be represented as a set of ordered pairs of the form (x, y), where x is a verb and y is a determiner:

$$(1) R_{\text{Sub}} = \{(x, y) \in L \times L \mid x \in V \wedge y \in D \wedge V \subset L \wedge D \subset L\}$$

Note that there is nothing mysterious about the syntactic relation of subcategorization, defined in this way. It is simply a set of ordered pairs of LIs, the first of which must be a verb, the second of which must be a determiner. In other words, the only notion that we really need in order to formally define the subcategorization relation is the concept of an ordered pair.

Consider next the relation of selection that is said to hold between functional categories such as C, T, D, etc. and their complements. It is standardly assumed that C selects TP, T selects VP, D selects NP, and so forth. If so, then the selection relation between D and N, say, can be represented as a relation $R_{\text{Sel}} = \{(x, y) \in L \times L \mid x \in D \wedge y \in N \wedge D, N \subset L\}$ and the relation between *the* and *boys* in the phrase *the boys* will be represented as an ordered pair of the form (the, boys). Similarly, the selection relation

between T and V is a set of ordered pairs, the first of which belongs to the subclass T and the second of which belongs to the subclass V; hence the relation between *will* and *arrive* in *John will arrive* can be represented by the ordered pair (will, arrive). Finally, the selection relation between *that* and *will* in *that John will arrive* can be represented by the ordered pair (that, will) and, likewise, the relation between *for* and *to* in *for John to arrive* by the ordered pair (for, to).

Now suppose we have an array of lexical items, each of which has zero or more selectors. A lexical item λ is chosen as the Locus, as discussed in the previous chapter. We then set about satisfying each of the selectors of the locus by successive applications of FormRel, producing ordered pairs of the form (x, y), where $x=\lambda$ and y is a lexical item having whatever properties are required by one of the selectors of λ . Only when all of the selectors of λ have been satisfied in this way are we free to select another lexical item from the array. Following Collins' terminology, a lexical item is said to be *saturated* if all of its selectors have been satisfied and *unsaturated* if one or more of them is still unsatisfied. When all the selectors of every lexical item in the array have been satisfied in this way, the lexical array is said to be saturated and the process of forming relations is complete. If any selector of any lexical item has not been satisfied, then the lexical array is unsaturated and the process of forming relations is incomplete. I assume that when a selector of λ has been satisfied, it is deleted from the lexical entry. A saturated LI thus contains no selectors, while an unsaturated LI contains at least one unsatisfied selector.

As in Collins' theory, the Locus Principle ensures that no relation can be formed between a lexical item and another unsaturated lexical item. Suppose, for example, the verb *kiss* is chosen as the Locus and the lexical items *the* and *boys* are also in the lexical

array. The subcategorization condition [__D] associated with *kiss* cannot be satisfied first by forming the ordered pair (kiss, the), because the selectional feature [__N] of the lexical item *the* has not yet been satisfied by forming a relation with a noun, hence is unsaturated. Therefore, the selection condition of *the* must be satisfied first by forming the ordered pair (the, boys), after which we are free to form the relation (kiss, the).

As mentioned in the previous chapter, there are no constituents in this theory. In the last example, there is no constituent [the boys] and the result of satisfying the subcategorization condition of *kiss* does not result in a constituent structure of the form: [kiss [the boys]] (with or without labels). Instead, there are simply two relations: (kiss, the) and (the, boys). It is worth elaborating on this point for a moment. There is a superficial similarity between a relational theory of the sort proposed here and a theory that incorporates Merge, or its equivalent, due to the fact that both involve the construction of sets. The operation Merge, however, goes far beyond what is involved in the relational theory. In the example just discussed, successive applications of the Merge operation would produce a syntactic object of the following form: {kiss, {the, boys}}. If this object were then merged with a member of the category T such as *will*, the result would be a new set: {will, {kiss, {the, boys}}}. Despite the fact that the outputs of successive applications of Merge are only unordered sets, each operation produces a new syntactic object *that incorporates the results of all the previous Merge operations*. Hence a theory with Merge clearly contains a notion of constituent structure. No such objects exist in the relational theory. In the example just discussed, there would be just the three ordered pairs: (will, kiss), (kiss, the), (the, boys). But, as we have seen, this is sufficient,

since all the essential properties of constituent structure can be derived from the legibility conditions at PHON.

1.1 Subcategorization vs. Selection

The term ‘selection’ was originally introduced by Abney(?) to distinguish the relation between functional categories and their complements from the relation between lexical categories and their complements, the latter being regarded as an instance of subcategorization. More recently, though the terminology is far from consistent, subcategorization seems to have come to be regarded as a special case of a more general relation of selection. In this work, as already indicated informally in the previous chapter, I shall use the terms ‘subcategorization’ and ‘selection’ to refer to two distinct syntactic relations, either of which can hold between a lexical or functional category and some other LI. Henceforth I reserve the term *argument* for the LI in the second coordinate of a subcategorization relation and the term *complement* for the LI in the second term of a selection relation. The basic idea behind this terminology is that subcategorization is a relation between a predicate and an argument, where an argument must be an entity expression, whereas selection is a relation between a predicate and a complement, where a complement must be either a property expression or a proposition.

To be more concrete, let us assume that there is an interpretation function F_I that maps syntactic relations onto the representations of SEM. It would be perfectly possible to apply the denotation function directly to syntactic relations, but since I am primarily concerned with syntax in this work, it is useful to adopt the strategy of mapping the LIs

and syntactic relations of English onto an intermediate representation at SEM. I shall assume, following Chierchia (1985, 1989) and Bowers (1993), that representations at SEM are drawn from a type-driven multisorted first-order language with four basic sorts: u , p , π , e . u is the type of basic entities; p is the type of propositions; π is the type of properties; and e is the universal sort. At the semantic level, then, subcategorization is realized as saturation of a function by an expression of type u , the type of basic entities, whereas selection is realized as saturation of a function by expressions of either type π , the type of properties, or type p , the type of propositions. It seems reasonable to hypothesize that the legibility conditions of CI require both kinds of relations at SEM. Predicate-argument structure is required in order to provide a compositional assignment of meaning to basic propositions, while predicate-complement structure is required in order to form an indefinite number of new complex predicates. If this approach is correct, then the existence of the basic syntactic relations R_{Sub} and R_{Sel} may ultimately be explained by the legibility conditions at SEM imposed by CI.

Following standard notation, I use primed terms α' , β' , etc. to represent the semantic interpretation of LIs α , β , etc. They are assigned directly in LEX. We must now specify how syntactic relations are to be mapped onto the representations of SEM. F_I operates on the relations $R_{\text{Sub}}(\alpha, \beta)$ and $R_{\text{Rel}}(\alpha, \beta)$ as follows:

(2) a. $F_I[(\alpha, \beta)] = \alpha'(\beta')$, where $(\alpha, \beta) \in R_{\text{Sub}}$, β' is of type u , α' is of type $\langle u, e \rangle$.

b. $F_I[(\alpha, \beta)] = \alpha'(\beta')$, where $(\alpha, \beta) \in R_{\text{Sel}}$, β' is of type π or p , α' is of type

$\langle \pi, e \rangle$ or $\langle p, e \rangle$.

I assume that F_I , like F_L , applies every time FormRel forms an ordered pair in NS. I refer to this as *Immediate Interpretation*, parallel to Immediate Spell-Out. Spell-Out and Interpretation thus apply in tandem with FormRel, building up representations at PHON and SEM at each step of the syntactic derivation.¹⁴

To be more concrete, consider how F_I applies in a standard case of subcategorization such as the example *kiss him* used above. In LEX, the semantic interpretation of the verb *kiss* is represented as $kiss'$ and that of *him* as he' (ignoring for the moment the difference in Case between *he* and *him*). I assume that he' is type u and that $kiss'$ is of type $\langle u, \pi \rangle$. Therefore by (2a), the representation of the syntactic relation $(kiss, him) \in R_{Sel}$ at SEM is: $kiss'(he')$ of type π , a property expression. But now consider the phrase *kiss the boys*. Syntactically, as shown above, we have the two relations $R_{Sub}(kiss, the)$ and $R_{Sel}(the, boys)$. In semantic interpretation, however, it is clear that the argument position of the function $kiss'(x)$ must be filled by the interpretation of the entire phrase *the boys*, not just by that of the D *the*. Parallel to F_L , this is explained by the incremental nature of the interpretation function: if a LI is selected from a previously formed relation, then the entire output of F_I at that step of the derivation must constitute (in part) the input to the next step of the derivation. In the case at hand, let us assume the

¹⁴ It is interesting to note that Immediate Interpretation was taken for granted in the earliest versions of transformational-generative grammar (Chomsky 1955, 1957, Katz and Fodor 1963, Katz and Postal 1964). Immediate Interpretation is also conceptually very similar to the “Rule-to-Rule” hypothesis (Bach 1988), assumed in most work within the framework of Montague Grammar and in some generative approaches inspired by both of these traditions, e.g. Bowers 1973, 1979, 1981, Bowers and Reichenbach 1979. In fact, Immediate Interpretation, as argued in Bowers 2001b, should be regarded as the null hypothesis, only to be abandoned in the face of compelling arguments to the contrary.

standard view that determiners such as the´ are functions from properties to entities, hence of type $\langle \pi, u \rangle$. Then application of F_1 to the relation (the, boys) yields the expression the´(boys´) of type u . This entire expression must then constitute part of the input to F_1 at the next step of the derivation. Therefore, when the new relation $R_{\text{Sub}}(\text{kiss}, \text{the})$ is formed (the LI *the* having been selected from the previously formed relation $R_{\text{Sel}}(\text{the}, \text{boys})$), the expression the´(boys´) must be substituted in the argument position of the function $\text{kiss}'(x)$, of type $\langle u, \pi \rangle$, yielding the interpretation $\text{kiss}'(\text{the}'(\text{boys}'))$, a property expression of type π . Note that this result follows independently from the fact that the interpretation of representations at SEM is type-driven. Since the´ is of type $\langle \pi, u \rangle$, it would be impossible to apply kiss' (of type $\langle u, \pi \rangle$) to it, whereas the output of the relation (the, boys), being of type u , can function as the argument of kiss' .

1.2. Interpretable vs. Uninterpretable Subcategorization Features

Chomsky (2000, 2001a) observes that the so-called EPP feature is similar to a selection feature (in the broad sense) in requiring that there be phonetic material of some kind in a given Spec position. In the theory proposed here, there is of course no such thing as a Specifier position in NS. However, a natural way of incorporating Chomsky's insight into the relational framework proposed here is simply to permit subcategorization features that lack a corresponding argument position in SEM. Consider, for example, the category T, for which the EPP was originally formulated. In languages like English there must be some phonetic material immediately to the left of T in PHON, either an entire constituent displaced from some other position or an expletive. However, the position to

the left of T is clearly not an argument position, as shown by the fact that the EPP requirement can be met by meaningless elements such as expletives, parts of idioms, etc. The “EPP effect” can be produced in a straightforward fashion if it is assumed that the category T in English has a subcategorization feature for which there is no corresponding argument position at SEM. One immediate advantage of this approach is that the feature [+/- interpretable] can be dispensed with entirely. An “interpretable” subcategorization feature is, by definition, one to which both F_L and F_I apply, whereas an “uninterpretable” subcategorization feature is one to which F_L , but not F_I , applies.

Consider, for example, the sentence *an explosion will occur*. Going back to the derivation in the previous chapter, the next step after (15) 4. is to form a selection relation between *will* and *v*, at the same time concatenating will to the left of the string an explosion occur:

- (3) 5. (will, *v*) will-an-explosion-occur-<an-explosion>-<occur>
6. (will, an) an-explosion-will-<an-explosion>-occur-<an-explosion>-<occur>

Since *will* has a subcategorization feature [$__D$], F_L is required to concatenate the phonetic form of the nearest D *an* (along with that of its selected LI *explosion*) to the left

of *will*, as shown in 6. However, because *will* does not require a semantic argument, F_1 will not affect its representation in SEM, hence the interpretation remains unchanged.¹⁵

We see then that the subcategorization relation need not be restricted to lexical categories such as V, but can also be associated with functional categories such as T, v , etc. However, it seems that one clear difference between lexical categories and functional categories is that only the latter may lack an accompanying argument position in SEM.

1.3 Selection By Lexical Categories

As mentioned above, the paradigm case of selection is the choice of a complement by a functional category. I am assuming, however, that lexical categories as well as functional categories can have selection features. In fact, the idea of analyzing certain kinds of predicate-complement combinations as, in essence, complex predicates is quite an old one. For example, Chomsky (1957) derives constructions such as *consider John incompetent*, *find the boy studying in the library*, etc. from underlying strings of the form: V – Comp - NP. Similarly, in Categorical Grammar and related literature (Dowty 1978, Chierchia 1984, Pollard 1984, and Klein and Sag 1985), raising constructions are often treated in terms of function composition. I propose to extend this treatment to non-nominal complementation in general. A full justification of this approach is reserved for Chapter 3 and 4. At this point I shall just sketch out the basic ideas.

¹⁵ Alternatively, if one wants to maintain that F_1 always applies, then the subcategorization relation in such cases can be interpreted as a λ -operator. But see note 4 in Chapter 3.

I assume, first of all, following Bowers (1993, 1997, 2001a, 2002) that all small clause complements, including PP, AP and predicate nominal constructions, are actually Pr/*v* complements that must have an argument in Spec of Pr/*v* at some point in the derivation. Second, I assume, following Bowers (1973[1986], 1979, 2001b), that obligatory control (OC) constructions are produced by an operation parallel to Raising.¹⁶ The difference between Raising and OC control constructions lies simply in whether the displacement of the complement subject is driven by an uninterpretable or an interpretable subcategorization feature. In the case of transitive control verbs such as *persuade*, *force*, etc. and intransitive control verbs such as *try*, *attempt*, *want*, etc., the verb (or its associated *v*, in the latter case) has a subcategorization feature that must be interpreted semantically as an argument. In the case of transitive raising verbs such as *expect*, *believe*, etc. and intransitive raising verbs such as *seem*, *appear*, *happen*, etc., on the other hand, there is a subcategorization feature associated with the functional categories T and *v* (Tr in the latter case, if Bowers 2002 is correct), respectively, which is not interpreted semantically as an argument. Crucially, however, what both raising and OC constructions have in common is the syntactic property of requiring a (defective) non-finite TP complement and the semantic property that they must combine with a proposition.

Consider, for example, the following sentences:

- (4) a. He tries to be nice.
 b. He seems to be nice.

¹⁶ See Hornstein 1999, 2001, for a somewhat different implementation of this idea.

In both cases the complement contains a predicate (simplifying the structure of the complement somewhat for ease of exposition) interpreted as $\text{nice}'(\text{he}')$ which must combine with the matrix verb, yielding in the first case the function $\text{try}'(\text{nice}'(\text{he}'))$ and in the second case the function $\text{seem}'(\text{nice}'(\text{he}'))$. Where the two constructions differ is that the displacement of the DP *he* in the first example yields an expression of the form $\text{try}'(\text{nice}'(\text{he}'))(\text{he}')$, whereas in the second example it yields an expression of the form $\text{seem}'(\text{nice}'(\text{he}'))$. Exactly the same analysis applies to pairs with small clause complements such as *she feels angry/she seems angry*, *I consider him crazy/I saw him drunk*, etc. except that complement in these cases is a bare Pr/vP, rather than an infinitival TP. Thus in the first pair of examples, the complex predicates $\text{feel}'(\text{angry}'(\text{he}'))$ and $\text{seem}'(\text{angry}'(\text{he}'))$ are formed in both cases, but they are then interpreted differently, depending on whether the matrix verb has an argument position or not. Similarly, sentences with PP-complements such as *I consider her in the know* vs. *I saw her in the hallway* share the process of forming complex predicates of the form $\text{consider}'(\text{in-the-know}'(\text{she}'))$ and $\text{see}'(\text{in-the-hallway}'(\text{she}'))$, but differ in whether the matrix predicate has an argument in object position or not.

I therefore hypothesize that all non-nominal complements are instances of the R_{Sel} relation in NS, whereas all nominal complements (apart from predicate nominals, which are actually small clause constructions) are instances of the R_{Sub} relation. F_L uniformly orders the former to the right of the matrix predicate and the latter to its left, while F_I uniformly maps the former onto a function that must be saturated by an expression of type u and the latter onto a function that must be saturated by an expression of type p .

The two basic syntactic relations of subcategorization and selection thus serve to mediate between the two fundamental types of function-argument structure required at SEM to satisfy the legibility constraints of CI and the two possible ways of linearizing subsequences of phonetic forms at PHON required to satisfy the legibility constraints of SM, thereby ensuring that there is a consistent and systematic mapping between the representations at SEM and those at PHON.

1.4 Why Syntactic Relations?

One possible objection to the picture just sketched out is the following. Why bother with syntactic relations at all? Why not just relate functional representations at SEM to linear ordering at PHON directly? Why does the language faculty need NS at all? In fact, just such an approach is frequently advocated, either explicitly or implicitly, in Categorical Grammar theories of natural language, especially recent work on “extended Categorical Grammar” (see, for example, the papers in Oehrle, Bach and Wheeler 1988 and the references therein).

The most obvious problem is that the number of categories that must be posited to achieve descriptive adequacy is infinite. Bach (1988: 23-27) explicitly addresses this point, admitting that “a lot (infinitely many) of the projected categories seem quite useless if not perverse.” Bach defends such approaches on the grounds that the categories “have a clear content and a built-in semantic import,” in contrast to features such as [+/-N], [+/-V], used in X-bar approaches to syntax (among others), whose import is far less clear.

The problem, however, is deeper than the mere fact that Categorical Grammar approaches require an indefinite number of syntactic categories. The real problem is that syntactic categories and relations have a dual function in natural language, because they must mediate between cognitive systems (CI and SM) that are utterly different in nature from one another. There are many aspects to this problem, so I will just focus here on one fundamental discrepancy between the representations at PHON and SEM, namely, the fact that the former, but not the latter, requires linear ordering relations and, conversely, that the latter, but not the former, requires functional relations. Despite the ingenuity of many recent extended Categorical Grammar analyses of natural language, the fact remains that the kinds of categories that the theory requires are not particularly appropriate for describing properties of PHON such as linear order, to say nothing of morphology, intonation, stress, etc.

The second major problem has to do with the lexicon. Categorical Grammar essentially builds particular properties of LIs into the definition of its categories. Thus an intransitive verb might be assigned to the category $S \setminus NP$ (using the notation of Dowty 1988), a transitive verb to the category $(S \setminus NP) / NP$, a ditransitive verb to the category $((S \setminus NP) / NP) / NP$, etc. In short, every particular property of a lexical item having to do with either functional semantic relations or with linear ordering relations must be built into the categorial system. This is arguably an unlearnable system, since it fails to separate the language particular properties of individual lexical items from those aspects of the $\langle SEM, PHON \rangle$ pairing that are predictable on the basis of universal principles.

Both of these problems are solved by introducing a small finite set of syntactic relations which are distinct from either the CI-motivated relations of SEM or the SM-

motivated relations of PHON and which are, at the same time, independent of the specific relational properties of individual LIs expressed in their subcategorization and selection features. The syntactic relations found in natural language syntax are sufficiently abstract and general enough to be mapped onto functional representations in SEM, on the one hand, and onto linear ordering relations in PHON, on the other. At the same time they are sufficiently few in number to provide a classification of LIs into easily learnable types. In short, the existence of a distinct set of syntactic relations is the (perhaps optimal) solution to the problem of mediating between SEM, PHON and LEX, while at the same time permitting the derivation of an infinite number of sentences.

2 Modification

I take up next the relation of modification. This relation has posed major difficulties for theories of constituent structure for quite some time. The basic problem is that there is no natural way in X-bar theory to account for the difference between expressions such as *walk slowly* and *eat lunch*. Both are phrases consisting of two words, the first of which is a verb in both cases. Both demonstrably form a constituent. Yet the relation between the words in the two cases is entirely different: *slowly* is a modifier of *walk*, whereas *lunch* is an argument of *eat*. An attempt was made to modify X-bar theory by introducing a new structural relation of *adjunction*, but that notion has turned out to be highly problematic in a number of ways. The distinction is still preserved, though in a rather different form, in bare phrase structure. In the latest version (Chomsky 2000: 133), the Merge operation is said to form *unordered sets* of elements when driven by subcategorization/selection

conditions (*Set-Merge*), but to form *ordered pairs* in the case of modification (*Pair-Merge*).

Conceptually, this is quite a strange idea, because it is clear, thinking in terms of relations, that the difference between *walk slowly* and *eat lunch* is simply that the latter is a relation between *eat* and *lunch*, while the former is a relation between *slowly* and *walk*. In other words, in *eat lunch*, the verb *eat* is the first coordinate of a binary relation (eat, lunch), whereas in *walk slowly*, the verb *walk* is the second coordinate of a binary relation (slowly, walk). Given the notion of an ordered pair, there is no simpler way of representing the difference between subcategorization and modification than this. In fact, a phrase such as *walk slowly* is just one instance of a more general relation of adverbial modification of the following form:

$$(5) R_{\text{Mod}} = \{(x, y) \in L \times L \mid x \in \text{Adv} \wedge y \in V \wedge \text{Adv}, V \subset L\}$$

A slight generalization of R_{Mod} will suffice to cover the relation between adjectival modifiers and nouns, e.g. *good boy*, adverbial modifiers of adjectives, e.g. *really tired*, and so forth.

I propose next, following Bowers (1993, 1999, 2001a, 2002), that just as verbs are marked with features indicating the category of the LIs they select or subcategorize, so adverbs are marked with features indicating the category of the LIs they modify. Thus an adverb such as *perfectly* has a selector of the form [$__V$], indicating that in an ordered pair of the form (perfectly, x), it must be the case that $x \in V$. An adverb such as *probably*, on the other hand, has a selector of the form [$__T$], while an adverb such as *stupidly* has

one of the form [$__v/Pr$]. Notice that this immediately accounts for the otherwise puzzling fact that adverbial modifiers are always optional. Whether or not an adverb occurs in a given sentence simply depends on whether or not it is present in the lexical array. If it is, then it occurs; if not, not. The relational theory thus accounts in the simplest possible way for the difference between modification and subcategorization/selection within a unified theory of selection, while at the same time accounting for the fact that modifiers are always optional.

2.1 Modification and Subcategorization

The relational approach to modification also solves a major problem that Collins (2003) encountered in attempting to extend the MLC to subcategorization in a label-free theory of Merge. Collins proposes to account for the fact that subcategorization/selection conditions are severely constrained to apply to the nearest c-commanded category of the appropriate type by treating the subcategorization/selection feature as a kind of probe, hence subject to the MLC. In order to explain the fact that the functional projection in an example such as the following doesn't block subcategorization:

(6) John looks too happy to leave.

he stipulates that the MLC applies to subcategorization in such a way that it is blocked just in case there is an intervening lexical category ([$+/-V, +/-N$]). The problem is why a prenominal adjective doesn't block selection of N by a D element such as *the*:

- (7) a. [the [smart [student]]]
 b. [the [very smart [student]]]

Noting that this is not a problem in the case of a branching AP such as *very smart* in (7b), Collins speculates (citing Rubin 1996) that perhaps prenominal adjectives are always branching categories, though he doesn't really argue very strongly for such an approach. In any case, it is clear that Rubin's theory, viz. introducing a new functional category Mod which selects AdvP and AP complements, is just another means of getting around the fact that X'-theory doesn't provide a natural way of distinguishing modification from subcategorization and selection.

Returning now to the relational approach, suppose the lexical array contains the words *the*, *smart*, and *student*. Adjectives, as we have just seen, modify nouns, meaning that they have a selector of the form [$__$ N]. Hence the selector of the adjective *smart* is satisfied by applying FormRel to form the relation (smart, student). Now recall that determiners select nouns. The noun *student* in this case is saturated, because it has no unsatisfied selectors. Hence there is nothing to prevent the determiner *the* from selecting *student*, constructing the relation (the, student). We therefore have the two relations: $R_{Mod} = (\text{smart}, \text{student})$ and $R_{Sel} = (\text{the}, \text{student})$. There is no blocking problem at all; it simply doesn't arise in the relational theory. The blocking problem, as can easily be seen now, is an artifact of a theory that is forced to represent all syntactic relations in terms of constituent structure. Even the weakened form of constituent structure in a theory of bare phrase structure without labels is sufficient to cause a problem in cases of this sort.

The points just made can perhaps be illustrated more perspicuously by introducing at this juncture a graphic notation for representing the derivation of networks of syntactic relations. One standard way of representing a relation between two elements is by means of a directed arrow $\bullet \rightarrow \bullet$ connecting two points. Since the basic elements of natural language are simply LIs, we can represent the relation between *the* and *student*, say, in the following way:

(8) the \rightarrow boys

If we wish to indicate explicitly what kind of relation holds between the two LIs, the arrow can be labeled as follows:

(9) the $\xrightarrow{R_{Sel}}$ boys

Now consider the relations that obtain in the phrase *kiss the boys*:

(10) $\begin{array}{c} R_{Sel} \\ \text{the} \rightarrow \text{boys} \\ R_{Sub} \uparrow \\ \text{kiss} \end{array}$

As (10) clearly shows, the two relations $R_{Sub}(\text{kiss}, \text{the})$ and $R_{Sel}(\text{the}, \text{boys})$ are dependent on one another. It is important to note, however, that there is also an inherent ordering relation between the two relations: the relation (the, boy) must be formed first, followed by formation of the relation (kiss, the). To be fully accurate, therefore, the arrows in (10) would have to be supplied with indices, so as to indicate the order in which the relations

are formed. As long as it is understood that such relational diagrams are a convenient means of representing *derivations*, rather than mere sets of relations, I shall generally suppress the indices, taking it for granted that the reader can supply the proper ordering.

Consider, in contrast, the relations that obtain in an expression such as *the smart student*:

$$(11) \quad \begin{array}{ccc} & R_{\text{Sel}} & \\ & \text{the} \rightarrow \text{student} & \\ & \uparrow R_{\text{Mod}} & \\ & \text{smart} & \end{array}$$

As the diagram makes clear, the two relations (the, student) and (smart, student) are orthogonal to one another. The notation thus shows very clearly why there is no blocking problem in the relational theory proposed here: the fact that there is a modification relation between *smart* and *the* does not in any way prevent *the* from forming a selection relation with *student*. Note, however, that the two relations are still inherently ordered: (smart, student) must be formed first, followed by (the, student). Hence there is no problem if *smart* was itself previously selected by a Degree element such as *very*:

$$(12) \quad \begin{array}{ccc} & R_{\text{Sel}} & \\ & \text{the} \rightarrow \text{student} & \\ & \uparrow R_{\text{Mod}} & \\ \text{very} \rightarrow \text{smart} & & \end{array}$$

Returning now to Collins' extension of the MLC to subcategorization, how could illegitimate subcategorization relations of the sort he is concerned with be prevented from arising in a relational theory? Suppose, taking one of his examples, there is a lexical array containing the complementizer *that* and suppose that the only available finite T

element has already entered into a relation with another complementizer, as for example in the phrase *to say (that) John is nice*. Given the theory of selection proposed earlier, the reason *that* can't enter into a relation with this phrase is that the non-finite T *to* lacks the feature [+finite] required by *that*. Our intuition is that *that* can't select the finite T in the lower clause because it has already been selected by another instance of *that*, hence is no longer accessible.

Before proposing a solution to this problem, let's first look at a different sort of case discussed by Collins. Consider the following structure:

$$(13) \quad H \ [_{XP} \ [_{YP} \ Y \] \ [_{X'} \ X \ ZP]]$$

Y is in [Spec, X]. Since no features intervene between H and Y, it should be possible for H to subcategorize Y. This possibility is clearly an artifact of a theory that has constituent structure, even of a very residual kind. From a relational point of view, it is a complete accident that Y happens to intervene between H and the category it is subcategorized for. If this conclusion were correct, it would predict that verbs and prepositions could subcategorize for possessive nouns in the Spec of their objects; that T could subcategorize for the internal subject; and so forth. Furthermore, it would predict that the possessive DP could be subcategorized by the verb in (14a), but not in (14b):

(14) a. John liked the girl's picture.

b. John liked the picture of the girl.

Here again, one's intuition is that the DP *the girl* in (14a) has already been subcategorized by the D-element that selected *picture* and is therefore not available to enter into the same kind of relation (namely, subcategorization) with *like*.

Consider finally the following hypothetical example:

(15) (*)The party LASTED [_{CP} for how many days [_{IP} he has been gone]].

This example is similar to Collins' hypothetical case of a verb whose subcategorization feature is satisfied by a PP headed by *on* in Spec of an embedded question. He suggests that the nonexistence of such verbs does not show that Specifiers cannot be subcategorized. Rather, such cases are not ruled out by virtue of the fact that *on* would have been subcategorized by two different verbs at different stages of the derivation.

(Notice the conceptual similarity of this principle to the intuition expressed above.)

However, (15) cannot be ruled out in this fashion. The time expression *for how many days* satisfies the subcategorization condition of a verb like *last*, but would not be doubly subcategorized in this structure, since it is an adjunct in the complement clause.

Assuming that there could not be a verb *LAST* with these properties, this is a problem for Collins' claim that Specifiers can be subcategorized.

Let us assume that this particular consequence of Collins' extension of the MLC is incorrect and that Specifiers cannot in fact be subcategorized. This leads one to wonder whether the MLC could be reformulated in relational terms so as to rule out all cases discussed so far. As suggested above, our intuition is that the reason *the girl* can't be subcategorized by *like* in (15a) is that *the girl* has already been subcategorized by

another lexical item and is therefore no longer available. Suppose, then, the MLC is reformulated along the following lines:

(16) Relational Minimal Link Condition (RMLC):

Suppose that lexical items X and Y have formed a relation $R_{\alpha}(X,Y)$. Then a lexical item Z may not form a relation $R_{\alpha}(Z,Y)$ of the same type with Y.

This solves both problems. In the first case, finite T (=Y) is selected by the first instance of *that* (=X). Then the RMLC dictates that Y cannot be selected by another lexical item *that* (=Z) with the same type of selector. Similarly, in the second case, *the girl* cannot be subcategorized both by the D-element that selects *picture* and by *like*. More generally, if it is the case that material in Spec comes to be in that position in PHON by virtue of a subcategorization relation with some LI, then it follows from the RMLC that such material cannot be subcategorized again by another LI. The RMLC thus sharply restricts the number of LIs that can form a given syntactic relation with another LI, requiring essentially that relations be unique, relative to a given relation of a particular type, and highly local in character.

Let us consider next the relation between a modifier and the element it modifies when that element is a phrase rather than a single word. It has been widely assumed in the literature of X-bar theory that adjectival and adverbial modifiers, which are generally analyzed as adjuncts, can only modify maximal projections. Thus a V-modifier such as *perfectly* (cf. Bowers 1993, 2001a, 2002) is assumed to modify the entire VP [throw the ball to Mary] in an expression such as *throw the ball to Mary perfectly*, so that there can

be no interpretations such as those indicated by the bracketings [[throw perfectly] the ball to Mary] and [[[throw the ball] perfectly] to Mary]. Unfortunately, X-bar theory does not provide any reason why there cannot be adjuncts to intermediate categories such as X' , hence there seems to be no principled way to rule out such bracketings.¹⁷ In the theory proposed here, in contrast, this result follows automatically from the LP. Recall that adverbs and adjectives, by hypothesis, have selection features such as [$_V$], [$_N$], [$_T$], etc. that indicate what category of LI they can modify. Suppose a verb such as *throw* is selected as the Locus. The LP requires that all the selectors of *throw* be satisfied before *throw* itself can be selected as the second coordinate of another relation. It follows that a V-modifier such as *perfectly* cannot form a relation with *throw* until after *throw* has formed relations with subcategorized and selected elements such as *the ball* and *to Mary*. Hence the condition that modifiers can only modify maximal projections follows from general principles in a relational theory of the sort proposed here.

2.2 Linearization of the Modification Relation

So far I have said nothing about how F_L applies to the modification relation R_{Mod} . This is a fairly complex topic and there are certain language-particular peculiarities of English that I will not try to account for here. It has often been observed that the positions in which adverbial modifiers can appear in PHON is freer in certain respects than those of other LIs. For example, Bowers (1993) notes that with the right intonational contour just about any type of adverb can appear on either a left branch or a right branch:

¹⁷ See, for example, the discussion of the ‘invisibility’ of X' in Chomsky (1995, Chapter 4).

- (17) a. John (probably) will win (probably).
 b. John has (stupidly) lost his keys (stupidly).
 c. John learned French (perfectly) from his teacher (perfectly).

One way to account for this would be to assume that F_L has two possible outputs when applied to modifiers:

$$(18) F_L(R_{Mod}(\alpha, \beta)) = \alpha-\beta \text{ or } \beta-\alpha$$

It seems likely, however, that which of the two outputs is chosen is in part a function of poorly understood stylistic and intonational factors. That being the case, I shall proceed on the assumption that modifiers in general precede the modified element in PHON.¹⁸

Now consider the derivation of the phrase *the smart student*:

- (19) 1. (smart, student) smart-student
 2. (the, student) the-smart-student

By (18), the phonological form of *smart* precedes that of *student*. By (8) in Chapter 1, the phonological form of *the* must precede that of *student*. However, since the output of

¹⁸ Note, however, that PP and small clause (SC) modifiers must generally follow the LI they modify, suggesting that further parameters must be built into F_L .

F_L at step 1. must be part of the input to F_L at step 2., it follows by the CO that the substring the must be ordered before the entire substring smart student, yielding the correct order shown above.

2.3 Interpretation of the Modification Relation

I conclude this section by discussing briefly the interpretation of R_{Mod} . I then show that certain apparent problems with the relational approach to modification can be solved if the interpretation of modifiers is taken account of.

In the semantic literature, modifiers are standardly assumed to have the following two properties: (i) the modifier is a function of which the modified is an argument; (ii) if $\langle a \rangle$ is the type of the modified LI, then the type of the modifier is $\langle a, a \rangle$. The first property is exactly what we would expect, given that the first coordinate of a syntactic relation corresponds, in general, to a function at SEM and the second coordinate to an argument. The second property expresses the fact that modifiers preserve the semantic type of the expressions they modify. Notice that this is precisely the property that is encoded in X'-theory by the adjunction operation: the result of adjoining an element Y to a constituent of category XP is another phrase of category XP. I maintain that the use of adjunction in NS is a redundant and unnecessary duplication of a notion that is more appropriately expressed at SEM. It is therefore a virtue of the relational approach to syntax that an operation such as adjunction is ruled out in principle.

To be more concrete, consider the interpretation of the phrase *the smart student*. Let us assume, as suggested above, that the interpretation of *smart* is of type $\langle \pi, \pi \rangle$, a

property modifier, that common nouns such as *student* are property expressions of type π , and that the D element *the* is of type $\langle \pi, u \rangle$. Then interpretation will proceed parallel to the syntactic derivation in the following manner:

(20) 1. $\text{smart}'(\text{student}'), \pi \quad R_{\text{Mod}}(\text{smart}, \text{student})$

2. $\text{the}'(\text{smart}'(\text{student}')), u \quad R_{\text{Sel}}(\text{the}, \text{student})$

Notice that the semantic derivation could not take place in the opposite order: if the' combined with $\text{student}'$ first, then the expression $\text{the}'(\text{student}')$ would be of type u , hence smart' , which is of type $\langle \pi, \pi \rangle$, would be inapplicable and we would be left with two unintegratable pieces of interpretation, violating compositionality. This is actually a welcome result, since it removes a certain indeterminacy in the syntactic derivation. Since both *smart* and *the* have selectors of the form $[__N]$, what would prevent the relation $(\text{the}, \text{student})$ from being formed first, followed by formation of the relation $(\text{smart}, \text{student})$, yielding the incorrect order *smart the student at PHON? Given the constraints on derivations developed so far, nothing would rule out such a derivation. In particular, notice that it is not ruled out by the RMLC, since R_{Sel} and R_{Mod} are different types of relations. Though we might attempt to prevent such derivations by adding further conditions to the RMLC, the prospects for such an approach do not seem very hopeful for the simple reason that the two relations, as observed earlier, do not interact with one another. However, as we have just seen, there is no way to assign an interpretation to

such a derivation, suggesting that rather than trying to rule out such derivations syntactically, it is better to rule them out at SEM.

A worse problem is posed by the fact that the modification relation apparently provides a class of systematic counterexamples to the RMLC. The latter, if correct as stated above, predicts that a noun should not be modifiable by more than one modifier. To see that this is so, consider the derivation of an expression such as *(the) tall smart student*:

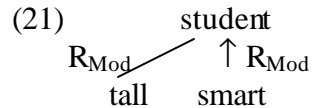

This is exactly the sort of relational network that is ruled out by the RMLC, since two separate LIs *tall* and *smart* have formed the same type of relation with the LI *student*. On the other hand, nothing prevents such a syntactic derivation from being interpreted semantically. Since adjectives are uniformly of type $\langle \pi, \pi \rangle$, the output of an operation that combines an adjective with a noun, producing an expression of the form $A'(N')$ (of type π), can always be the input to another operation of the same sort, producing interpretations of the form: $\text{the}'(\text{tall}'(\text{smart}'(\text{student}')))$, $\text{the}'(\text{nice}'(\text{tall}'(\text{smart}'(\text{student}'))))$, etc. Notice that F_L also produces perfectly well formed strings at PHON of the form: the tall smart student, the nice tall smart student, etc.

We thus have apparent counterexamples to the RMLC of two kinds: cases where the RMLC incorrectly rules out derivations that are well-formed at both SEM and PHON and cases where the RMLC fails to rule out derivations that are ill-formed at both SEM

and PHON. This suggests one of two conclusions: either the RMLC is formulated incorrectly or else FormRel should apply freely, leaving its results at SEM and PHON to be ruled out by the legibility conditions that are applicable at those levels. I will attempt to decide which of these two alternatives is correct after looking at further relevant data in the next two chapters.

3 Summary

The function-argument structures required at SEM and the linear ordering relations required at PHON are mediated by networks of relations between LIs built up from three basic types of relations: subcategorization, selection and modification. These three basic relations are realized semantically by predicate-argument structures, predicate-complement structures and modifier-modified structures, respectively. These structures in turn are required by the minimal legibility conditions imposed on SEM by CI. Though the syntactic relations are "projected," in a certain sense, from the corresponding function-argument structures at SEM, the former cannot simply be reduced to the latter for a variety of reasons. Rather, it appears that syntactic relations are needed to mediate in an optimal fashion between the very different types of representations required at SEM and PHON. Previous theories have erred in attempting, on the one hand, to build certain aspects of the representations of PHON (linear order, constituents, morphology, etc.) into syntactic representations and, on the other, in attempting to build certain aspects of the representations of SEM (functional relations, semantic types, etc.) into syntactic representations. As work within the minimalist program has made clear, the real goal

should be to eliminate from NS everything that is not required by the legibility conditions imposed on SEM and PHON. So far, it appears that the bare minimum required in NS are the three basic syntactic relations of subcategorization, selection and modification, together with an operation FormRel that forms ordered pairs of LIs in sequential fashion, subject to computational constraints such as LP,CO and perhaps some version of the RMLC. Each time FormRel applies, a corresponding operation takes place in SEM and PHON, so that representations at these levels are built up in tandem with the derivations of NS. In the next three chapters, this basic model will be tested by extending it to other kinds of relations that appear to be necessary in human language.

Chapter 3

Agreement

I take up next a very different sort of syntactic relation. According to Chomsky (2000, 2001a) the Agree relation holds between X and Y when the uninterpretable ϕ -features of X match the interpretable ϕ -features of Y and are valued and transferred to the phonetic component by Spell-Out (SO), as is the uninterpretable Case feature of Y. Unlike subcategorization, selection and modification, agreement is not directly connected to linear ordering relations at PHON. Instead its effects are characteristically morphophonological in nature (Chapter 1, section 6). Agreement can also be long distance, unlike the fundamental relations of subcategorization, selection and modification. Why should the computational system of natural language have such a relation? The minimalist program does not really provide a clear answer to this question, though Chomsky (2001a: 3) has speculated that “both [the relation Agree and uninterpretable features] may be part of an optimal solution to minimal design specifications by virtue of their role in establishing the property of ‘displacement,’ which has (at least plausible) external motivation in terms of distinct kinds of semantic interpretation and perhaps processing.” While it is possible that considerations of this kind might play a role in explaining certain kinds of displacements (notably Object Shift in Icelandic, Scrambling, etc.), I will take a different approach to the question of why a *prima facie* imperfection such as the Agree relation exists.

The most basic syntactic relations are of course subcategorization, selection and modification, as has been shown in the preceding chapters. These relations constitute the absolute minimum that is required to mediate between the basic function-argument structures that are required at SEM and the most basic property of representations at PHON, namely, linear ordering. If the main problem of language design was simply to find the optimal means of mapping basic function-argument structures onto linear ordering relations, then this could be accomplished straightforwardly with the minimal syntactic apparatus that has been developed so far. Surprisingly, such simple systems are never found. Instead, it appears that languages universally require more complex syntactic relations that go beyond the basic relations discussed up to this point.

If the human language capacity is really an optimal system, then the existence of these more complex relations must arise somehow from the legibility conditions imposed on SEM and PHON by CI and SM, respectively. Accordingly, I shall attempt to demonstrate in this chapter that the existence of the Agree relation in syntax is the optimal solution to the problem of representing two properties that I shall refer to as *clausality* and *transitivity*. These two properties are in turn closely connected with the two fundamental processes of *predication* and *property formation*, respectively. I therefore begin by discussing the syntax and semantics of predication and property formation. I next show how clausality and transitivity arise from predication and property formation. I then show that the existence of the Agree relation is the optimal solution to the problem of mediating between semantic properties of clausality and transitivity, on the one hand, and the morphophonological processes of agreement and case assignment, on the other. Finally, I address a number of computational problems

posed by the new syntactic apparatus introduced in this chapter, concluding with a reformulation of the RMLC.

1 The Syntax and Semantics of Predication and Property Formation

In this section I first discuss the semantics of predication, after which I discuss the semantics of property formation. I then go on to show that the basic syntactic relations discussed in the previous chapters, together with the new syntactic category Pr, provide a near optimal solution to the problem of mediating between the representations of predication and property formation at SEM and PHON.

1.1 Predication

There is only one category apart from the lexical categories V, N, A, P that is absolutely obligatory in natural language syntax: the category that mediates the predication relation. I have argued previously (Bowers 1993, 1997, 2001a, 2002) that there is an obligatory substantive category 'Pr', of which Chomsky's light verb *v* is one possible realization, which has at least the following properties: (i) it is the position to which the verb obligatorily moves in main clauses in languages like English; (ii) it can be selected by T, but can also be selected by a lexical category or occur as a modifier, yielding small clause (SC) complements and adjuncts, respectively; (iii) it selects either Tr or V, yielding transitive and intransitive structures, respectively; (iv) it may subcategorize may either an argument or a non-argument; (v) if the former, then its Spec is occupied by the external

argument of transitive or unergative verbs; (vi) if the latter, then its Spec may be filled either by merging an expletive or a copy of the nearest LI of the right category; (vii) in the latter case, either an internal argument of the verb may move to Spec or a variety of other constituents, including locative expressions, progressive and passive VPs, etc. I shall try to demonstrate below that this nexus of relations involving the category Pr can be derived quite naturally within a bare relational approach to syntax.

In English, the Pr category is realized in main clauses either as a phonetically uninterpretable LI v or by the LIs *be*, *get* and *have* (Bowers 2002). In SC constructions it is realized either by the phonetically null (but interpretable) LI \emptyset or by the LI *as*. Cross-linguistically, Pr is realized in both main clauses and SCs by lexical material of various kinds (see Bowers 2001a, for a brief survey). v selects either Tr or V.

Let's consider next the basic semantics of predication. As already mentioned in Chapter 2, I assume, following Chierchia (1985, 1989) and Bowers (1993), that the representations at SEM are drawn from a type-driven multisorted first-order language with three basic sorts: u , the type of basic entities; π , the type of properties; and p , the type of propositions. Since properties and propositions are basic types in this theory, there is no direct connection between them, as there is in classical type theory.

Therefore, it is necessary either to turn a property into a proposition directly or to turn it into a Fregean unsaturated structure, that is, a propositional function, which can in turn combine with an entity expression to form a proposition. Let us suppose that LIs that belong to the basic lexical categories V, A, N, and P are properties, semantically. Then the semantic function of Pr, following Bowers (1993), is precisely to map properties (expressions of type π) into propositions (expressions of type p) or into propositional

functions (expressions of type $\langle u, p \rangle$).¹⁹ Let us represent the translation of v as v' . Then the type of v' is either $\langle \pi, p \rangle$ or $\langle \pi, \langle u, p \rangle \rangle$, depending on whether it requires an external argument or not. Examples of predicates that lack an external argument are “impersonal” predicates such as *rain* or *seem* and unaccusative verbs such as *occur*, *become*, *roll*, etc., as well as the impersonal transitive verbs such as *ubit'*, *tosnit'*, etc. that occur in Russian, among other languages, though not in English (see Bowers 2002, for discussion):

(1) a. It rained.

b. It seems that he is tall.

c. An explosion occurred.

d. There occurred an explosion.

e. Rabocego ubilo oskolkom plity

worker killed shard of concrete slab

acc 3P/sg/neut instr

‘A worker was killed by a shard of concrete slab.’

Examples of predicates that require an external argument are intransitive unergative verbs such as *cough*, *cry*, etc., all transitive verbs, as well as verbs such as *think*, *say*, etc. which require an external argument and a sentential complement:

¹⁹ The former correspond to what Kuroda (1972) calls ‘thetic’ judgments and latter to what he calls ‘categorical’ judgments.

- (2) a. He coughed.
 b. He kissed her.
 c. He thinks that she is tall.

Notice that in all the examples of (1) there is phonetic material to the left of the verb,²⁰ despite the fact that semantically these predicates have no external argument. This reflects the fact that in English and many other languages²¹ the category Pr has an obligatory subcategorization feature in the syntax. For predicates with an external argument, such as those in (2), the external argument simultaneously satisfies the syntactic subcategorization feature of v and the semantic requirement of v' that the propositional function be saturated by an entity expression. Thus the derivation of (2a), together with its semantic and phonetic interpretation, would proceed as follows:

- (3) 1. $v'(\text{cough}')$, $\langle u, p \rangle$ $R_{\text{Sel}}(v, \text{cough})$ cough- $\langle \text{cough} \rangle$
 2. $(v'(\text{cough}'))(\text{he}')$, p $R_{\text{Sub}}(v, \text{he})$ he-cough- $\langle \text{cough} \rangle$

For predicates that lack an external argument, on the other hand, the subcategorization requirement of v can only be met either by forming a relation between v and an expletive, as in (1a, b, d, e), or by forming a relation with the internal argument, as in (1c). The

²⁰ I assume, following Perlmutter 2001, Perlmutter and Moore 2001, Moore and Perlmutter 2001, that there is a silent expletive in impersonal constructions in Russian. For the opposing view that impersonal sentences are subjectless, see Babby 1989 and Lavine 2000.

²¹ Perhaps universally if Rothstein (1983, 2001) is correct.

semantic interpretation is, however, completely unaffected by these operations in the syntax and at PHON, since expletives and copies have no interpretation in SEM.²² These points are illustrated in the following derivations:

- | | | | | |
|-----|----|-----------------------------|----------------------------------------|----------------|
| (4) | 1. | $v'(\text{rain}'), p$ | $R_{\text{Sel}}(v, \text{rain})$ | rain-<rain> |
| | 2. | same | $R_{\text{Sub}}(v, \text{it})$ | it-rain-<rain> |
| (5) | 1. | $an'(\text{explosion}'), u$ | $R_{\text{Sel}}(an, \text{explosion})$ | an-explosion |

²² It is sometimes suggested (e.g. Chierchia 1984) that expletives be translated by a type-shifting operation E of “expletivization” whose logical type is $p \rightarrow \pi$. Applied to a proposition such as $seem'(p)$, E yields a property $E(seem'(p))$. This property, when predicated of an arbitrary funny object \perp , yields the proposition $seem'(p)$; when applied to anything other than \perp , it is undefined. While fairly harmless in and of itself, this maneuver seems ultimately to miss two crucial points: (a) sentences with expletive subjects are not in fact propositional functions semantically; (b) expletive subjects are required for purely syntactic and phonological reasons and simply have no semantic reflex at all.

Similarly, it is often suggested that unaccusative sentences should be translated as λ -expressions at the sentential level, so that the translation of step 3. of (5), for example, would be an expression of the form: $\lambda x[v'(\text{occur}'(x))]$ (of type $\langle u, p \rangle$), which when applied to the displaced argument $an'(\text{explosion}')$, yields, by λ -reduction, the expression: $v'(\text{occur}'(an'(\text{explosion}')))$ at step 4. of the derivation. Again, this preserves the idea that all sentences are propositional functions at the cost of introducing a redundant and unnecessary semantic operation. The real point is that unaccusatives (like impersonals) are, despite appearances,thetic rather than categorical judgments (see note 3) in which the displacement of the internal subject at PHON takes place for purely syntactic and phonological reasons.

2. occur'(an'(explosion')), π $R_{\text{Sub}}(\text{occur}, \text{an})$ an-explosion-occur
3. v'(occur'(an'(explosion'))), p $R_{\text{Sel}}(v, \text{occur})$ occur-an-explosion-
<occur>
4. same $R_{\text{Sub}}(v, \text{an})$ an-explosion-occur-<an-
explosion>-<occur>

What determines whether v subcategorizes an expletive or a copy of the D that heads the internal argument? It is shown in Bowers (2002) that this is completely predictable on the basis of the syntactic properties of the predicates and expletives in question.

Basically, if there is no internal argument of category D, then the expletive must be *it* (which has ϕ -features), in order to satisfy the Agreement requirements of T; if there is an internal argument, then the subcategorization feature of Pr can be satisfied either by forming a relation with the internal argument or by forming a relation with *there* (which has no ϕ -features), the Agreement requirements of T being satisfied in either case by forming a relation with the ϕ -features of the internal argument (see section 2.1.1, for discussion).

In order to ensure that specific lexical verbs match up correctly with categorical andthetic v , so that we don't produce **it screamed* (with expletive *it*), on the one hand, or **he rained*, on the other, I shall assume that v and V must agree in the value of the feature [+/-Cat(egorical)]. If v' has the feature [+Cat], then it is of type $\langle \pi, \langle u, p \rangle \rangle$; if it has the feature [-Cat], then it is of type $\langle \pi, p \rangle$. Note that for verbs such as *roll* that are either

transitive or unaccusative (categorical or thematic) the value of the feature [+/-Cat] need not be specified.

Finally, how is it possible for languages like Russian to have impersonal transitives such as (1e), for which there is no equivalent in languages like English (e.g. **it killed the worker with a shard of concrete*, or the like)? I return to this question shortly. Such sentences in fact provide crucial evidence for the existence of the category Tr.

1.2 Property Formation

As we have just seen, the predication operation creates two types of expressions: pure propositions, of type p, and propositional functions, of type $\langle u, p \rangle$. Property expressions divide up in exactly parallel fashion into pure property expressions, of type π , and property functions, of type $\langle u, \pi \rangle$. Examples of the former are intransitive, unergative predicates such as *cough*, *scream*, etc. and impersonal predicates such as *rain*, *snow*, etc. Examples of the latter are intransitive, unaccusative predicates such as *occur*, *become*, *roll*, etc. and transitive predicates such as *kiss*, *hit*, etc. Hence the semantic representation of *cough* is simply *cough'*, of type π . The semantic representation of *kiss*, on the other hand, is *kiss'(x)*, of type $\langle u, \pi \rangle$, which must combine with an expression of type u, such as *she'*, to produce a property expression of the form *kiss'(she')*, of type π . The different types of property expressions are mapped onto the different types of propositions via the predication operation to produce the following typology of basic predicates:

(6)

Predication		Proposition types	
		$\langle u, p \rangle$	p
Property types	$\langle u, \pi \rangle$	2-place (transitive)	1-place (unaccusative)
	π	1-place (unergative)	0-place (impersonal)

Notice, however, that both basic properties and property functions can themselves be derived from propositions. This is the process of property formation. It is the semantic correlate of the syntactic selection relation, whose function, as described in the previous chapter, is to combine a predicate with a complement to form a complex predicate. Consider, for example, the sentence *it seems that John has left*. The type of the verb *seem* in this case is $\langle p, \pi \rangle$, that is, it combines with a proposition to form a property. Since the subject *it* in this case is clearly a non-referential expletive,²³ the predication operation in this instance is of type $\langle \pi, p \rangle$. Sentences of this type thus have a complement, but neither a subject nor an object. Suppose the verb is the same type as *seem*, but the predication operator is of type $\langle \pi, \langle u, p \rangle \rangle$. This is the semantic type of a sentence such as *he thinks that John has left*, with a subject and complement, but no object. A verb can also be of type $\langle p, \langle u, \pi \rangle \rangle$, mapping a proposition onto a property function. If the predication operator also requires an argument (i.e. if it maps a property onto a propositional function), then we get sentences such as *he persuaded me that John had left*, with both a subject and an object, as well as a complement. Finally, suppose

²³ That *it* is a true expletive here is shown by two facts: (i) the complement cannot replace *it* in subject position: **that John has left seems*, cp. *that John has left bothers me*; (ii) it cannot be clefted: **what seems is that John has left*, cp. *what bothers me is that John has left*.

that the verb is the same type as *persuade* and the predication operator is *thetic*. An example of such a verb might be *strike* in a sentence such as *it strikes me that John has left*, with an object and a complement, but no subject. We thus have the following typology of complex verbs:

$$\begin{array}{rcl}
 & & p \quad v'(\text{seem}'(p)) \\
 & \pi \rightarrow & \\
 (7) & & \langle u, p \rangle \quad (v'(\text{think}'(p))(\text{he}')) \\
 & p \rightarrow & \\
 & & p \quad v'(\text{strike}'(p))(\text{me}') \\
 & \langle u, \pi \rangle \rightarrow & \\
 & & \langle u, p \rangle \quad (v'(\text{persuade}'(p))(\text{me}')(\text{he}'))
 \end{array}$$

It is interesting to note that property formation and predication are just inverses of one another: the former turns a proposition into a property or property function, while the latter turns a property into a proposition or propositional function. Thus a complex sentence with several embeddings, e.g. *He thinks that she knows that they have left*, reduces, in effect, to a series of alternating inverse mappings: $p \rightarrow \pi \rightarrow p \rightarrow \pi \rightarrow p$. Note also that in all the examples discussed so far, the complement is finite; consequently there is no interaction between the predicate of the main clause and the internal arguments of the complement. The opposite is true in nonfinite complements: why this is so will be explained and discussed extensively in Chapter 4.

1.3 The Optimal Representation of Predication and Property Formation

I now show that the addition of the single syntactic category Pr to the inventory of basic lexical categories, together with the basic syntactic relations introduced in the previous

chapters and the linearization and interpretation functions F_L and F_I , leads to a near optimal solution to the problem of mediating between the processes of predication and property formation required at SEM and the linear ordering relations required at PHON.

Let us start by considering the case in which the predication operation produces a propositional function. In order to ensure that predication is consistently reflected in the linear ordering of elements at PHON, there must minimally be a functional category Pr which selects a verbal element that is semantically a property expression and which subcategorizes a determiner element that is semantically an entity expression. The principles that have already been discussed will then ensure that there is a fixed linear order between the phonetic form of the determiner element and the phonetic realization of the verbal element. Schematically, then, the syntactic relations involved in predication and the corresponding representations at SEM and PHON are as follows:

$$(8) \quad (\text{Pr}'(\text{VP}'))(\text{DP}'), p \quad \begin{array}{c} \text{D} \\ \uparrow \text{R}_{\text{Sub}} \\ \text{Pr} \rightarrow \text{V} \\ \text{R}_{\text{Sel}} \end{array} \quad \text{DP-Pr-VP}$$

As we have seen, however, it is also possible for the predication operator to map a property directly into a proposition. In this case, even though no external argument is required semantically, the obligatory subcategorization condition of Pr nevertheless requires that a relation be formed with a semantically vacuous expletive (or with a copy of the internal argument in the case of unaccusatives, passives, etc.). The linearization function F_L in turn ensures that a token of the phonetic realization of the subcategorized element is linearly ordered to the left of the phonetic realization of Pr, thus marking, in

effect, the case where v' is of type $\langle \pi, p \rangle$. Schematically, those two cases look as follows:

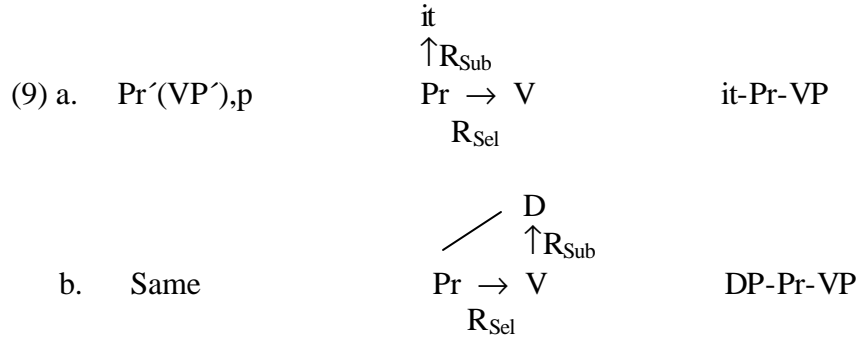

In short, given minimal legibility conditions at SEM (the predication operation) and PHON (linear order), the syntactic relations that I have proposed for predication mediate between SEM and PHON in a way that is close to optimal.

The relations involved in property formation are almost exactly parallel. Consider first the case in which a predicate maps a proposition onto a property function. In order to ensure that property formation is consistently reflected in the linear ordering of elements at PHON, the verb must minimally select a complement that is semantically a proposition and subcategorize a determiner that is semantically an entity expression. Schematically, the syntactic relations involved, together with the corresponding representations at SEM and PHON are as follows:

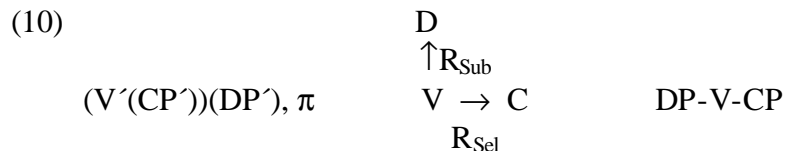

By analogy, there should be two cases where a proposition is mapped directly onto a property, parallel to (9a) and (9b). In the latter case, the verb would subcategorize a D

internal to the complement: cases of this sort will be discussed extensively in the next chapter. In the former case, we would expect there to be verbs that *require* an expletive *it* in object position, parallel to the expletive *it* that is required in subject position by verbs such as *seem*:

$$(11) \quad V'(CP'), \pi \quad \begin{array}{c} (it?) \\ \uparrow R_{Sub} \\ V \rightarrow C \\ R_{Sel} \end{array} \quad (it?)-V-CP$$

Interestingly, as Kiparsky and Kiparsky (1971) observed some time ago, there is a class of verbs (*resent*, *dislike*, etc.) for which an expletive in object position is obligatory:

(12) John resents/dislikes *(it) that they compare him to Mozart.

However, most verbs that take *that*-complements behave in exactly the opposite fashion:

(13) John thinks (*it) that they compare him to Mozart.

Hence it appears that there is an asymmetry in this respect between expletive subjects and expletive objects. Why are expletives always required in subject position, but not in object position? A straightforward answer might appear to be the following: Pr has an obligatory subcategorization feature, whereas individual verbs may vary in whether they have a subcategorization feature or not. However, it will become clear in the next chapter that LIs that belong to basic lexical categories such as V can never have a true

EPP feature, so that a different explanation for the obligatory expletive in examples such as (12) will have to be sought.²⁴

2 Clausality and Transitivity

Having outlined the basic semantic, syntactic and phonological properties of predication and property formation, I turn next to the related properties of clausality and transitivity, starting with the latter, which is simpler to deal with in certain respects. I then show that transitivity is closely connected to, but not reducible to, object agreement, and likewise that clausality is tied to, though not reducible to, subject agreement.

2.1 Transitivity and Object Agreement

Let us start by considering some puzzling features of property formation that the theory outlined above fails to account for. Notice, for example, that while the proposed semantic typology appears to classify predicates correctly in terms of number of arguments (valency) and argument-types (position with respect to the type of properties and propositions), it still fails to account fully for the property of transitivity. Compare an unaccusative predicate such as *arrive* with the Russian impersonal transitive form

²⁴ The most plausible explanation is an updated version of Kiparsky and Kiparsky's (1971) idea that these complements are actually DPs containing a sentential complement. Hence they would be subcategorized,

ubilo ‘kill-3P/sing/neut’ discussed in the previous section. Both verbs are 1-place property functions, yet *ubilo* is transitive, while *arrive* is intransitive. On the other hand, compare *arrive* with an English passive form such as *be killed* or a middle form such as *the book reads well*. The unaccusative verb is clearly intransitive, while passive and middle forms feel transitive, even though the internal argument in all three is the subject with respect to linear order, Case, and Agreement. It seems that there must be some additional property that is still not accounted for in this typology. I shall henceforth refer to this extra property by the term *transitivity* and I shall try to show that it must be represented syntactically as a relation between a new functional category ‘Tr’ and V. I start by considering the syntactic evidence in support of such an analysis.

There is considerable evidence (see Bowers 2002 and the references therein, especially Koizumi 1993, 1995) that there is a substantive functional category ‘Tr’ (standing for ‘transitivity’) that occurs between V and Pr. Tr obligatorily selects V, while Pr may select either Tr or V. If Pr selects Tr, the result is a *transitive* structure, whereas if Pr selects V, an *intransitive* structure results. I assume that in English Tr is realized by a phonetically uninterpretable element τ that is always replaced in PHON by the verb it selects for the reasons discussed in Chapter 1. However, Tr can be realized by an independent morpheme in some languages (see below and Bowers 2002, for discussion of Scottish Gaelic, and Collins 2000, for discussion of Khoisan), in which case displacement of the verb is blocked. I assume in addition, adopting a relational version of the probe-goal approach to agreement and Case assignment (Chomsky 2000, 2001a),

rather than selected, in the framework proposed here. Similarly, complements of verbs such as *bother*, *surprise*, *annoy*, etc. are most likely nominal subjects, as proposed originally by Rosenbaum (1967).

that there is a relation R_{Agr} between the unvalued ϕ -features of Tr and the nearest set of matching intrinsic ϕ -features and structural Case feature associated with some LI of category D. As in the probe-goal theory, I assume that the unvalued ϕ -features of Tr and the structural Case feature of D are valued when FormRel establishes a relation between the two sets of ϕ -features. Schematically, this nexus of relations can be derived as shown in the following diagram:

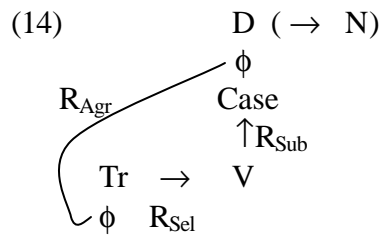

As indicated by the curvy arrow, there is an agreement relation between the ϕ -features of Tr and the ϕ -features and Case feature of D. But what is the direction of the relation? Is ϕ_{Tr} the first coordinate and ϕ_D the second coordinate, or vice-versa? Clearly the relation is asymmetrical, as is revealed by the stipulation that the ϕ -features of Tr are *valued* by the ϕ -features of D. Obviously this asymmetry is due to the fact that the ϕ -features of the goal are intrinsically valued (interpretable), whereas the ϕ -features of the probe are not (uninterpretable). This suggests that the direction of the relation is from Tr to D, as in the probe-goal theory, since it is the second coordinate D, rather than the first coordinate Tr, that has intrinsic ϕ -features. The fact that the second coordinate has an unvalued Case feature whose value depends on properties of the first coordinate (accusative if Tr,

nominative if T) further reinforces this conclusion.²⁵ I therefore assume that the relation $R_{Agr} = (\phi_{Tr}, \phi_D)$ can be formed just in case the features ϕ_{Tr} and ϕ_D match, meaning that Tr and D have the same set of features. If ϕ_{Tr} and ϕ_D match, then the unvalued ϕ -features of Tr are assigned values that are equal to those of the intrinsically valued ϕ -features of D. The uninterpretable Case feature of D is assigned a value by Tr at the same time. As soon as valuation takes place, a morphological function F_M selects the correct morphological forms of Tr and D and the uninterpretable ϕ -features of Tr and the Case feature of D are erased in NS.

Returning now to derivation (14), notice that the relation R_{Agr} picks out the closest LI of category D with matching ϕ -features. At the same time, Tr selects V, which in turn subcategorizes D. Hence the relation R_{Agr} , in effect, picks out the internal argument of the verb and gives it a special status as the “direct object” of the sentence, at the same time making the transitivity relation visible at PHON by virtue of the morphological Spell Out operation F_M , which spells out a morphological agreement relation and/or case-marking. Now if it were the case that object agreement morphology and/or accusative Case assignment took place if and only if the predicate had an internal argument, then there would be no reason for the verb not to agree with and assign Case to the internal argument as soon as the subcategorization relation was established between the two.²⁶ In

²⁵ Chomsky (2000, 2001a) assumes that Case and Agreement are always associated with one another. There is, however, evidence in some languages that the two processes can be dissociated (Ura 2000).

²⁶ So-called “inherent” Case is assigned in exactly this way, that is to say, in conjunction with satisfaction of an (interpretable) subcategorization or selection relation. Thus inherent Case does indeed mark specific types of arguments or complements, whereas structural Case marks the more abstract relation of transitivity.

fact, however, the implication is falsified in both directions. First, in unaccusative sentences, the internal argument of the verb is *not* elevated to the status of a direct object and, as will be shown shortly, it has no option in that case but to be marked as the “subject.” Second, there are cases, which will be discussed in detail in Chapter 4, in which there is agreement between and assignment of Case to a D other than the internal argument. Since R_{Agr} cannot be associated with any fixed argument of the verb, it follows, as suggested above, that there must be some extra property that it is associated with. It is this property, which I refer to as *transitivity*, that is represented syntactically by the category Tr. My hypothesis, then, is that the existence of the syntactic relation R_{Agr} is the optimal solution to the problem of representing a non-local property such as transitivity in a consistent manner at PHON. Before considering other instances of the relation R_{Agr} , I first look at some specific examples of transitivity.

2.1.1 *Transitivity Marking in Scottish Gaelic*

One question that has not been considered so far is whether Tr is like T in having an EPP feature (i.e. an uninterpretable subcategorization feature). A particularly revealing example is provided by transitivity marking in Scottish Gaelic. Consider the following data:

(15) a. Bha Calum air ambalach a fhaicinn.

be-past Calum perf the boy ϕ_O see

‘Calum has seen (perf.) the boy’

- b. Bha Calum a' faicinn a'bhalaich.
 be-past “ imperf see the boy-gen
 ‘Calum was seeing (imperf.) (=’looked at’) the boy’

Ramchand (1997) and others have argued that the morpheme *a* in (15a) is (as indicated by the gloss) an object agreement morpheme. Bowers (2002) suggests that the presence of the perfective morpheme *air* in *v/Pr* in (15a) (and likewise of the imperfective morpheme *a'* in (15b)) prevents raising of the verb. Interestingly, the accusative Case-marked object in (15a) must *precede* the verb, whereas the genitive Case-marked object in (15b) must *follow* it. This pattern is easily explained if it is assumed: (i) that Tr is present in (15a) but not in (15b); (ii) that Tr has an EPP feature whose reflex in PHON is placement of an occurrence of the object *ambalach* to the left of *a*. The derivation of (15a) would then proceed as follows:

- (16) 1. $R_{Sel}(am, balach)$ a[m]-balach
 ϕ
 Case
 2. $R_{Sub}(fhaicinn, am)$ a[m]-balach- fhaicinn
 3. $R_{Sel}(a, fhaicinn)$ a-a[m]-balach- fhaicinn
 ϕ
 4. $R_{Agr}(\phi_a, \phi_{am})$ a-am-balach-fhaicinn
 Case \Rightarrow acc

2.1.2 Short Verb Movement (SOM) in English

In languages like English Tr is not realized phonetically as an independent morpheme in NS. Instead, it is realized by the phonetically uninterpretable symbol τ , which must be replaced in PHON by the phonetic form of the verb it selects. Therefore the effect of the EPP feature of Tr cannot be observed directly. Nevertheless it can be observed indirectly, as argued at length in Bowers (2002), when the sentence contains a V-modifying adverb of the sort discussed in the previous chapter. Consider the following data:

- (18) a. Mary threw the ball perfectly to John.
 b. *Mary perfectly threw the ball to John.
 c. *Mary threw perfectly the ball to John.

(18b) shows that *perfectly* is a V-modifying adverb. Hence it cannot form a relation with *throw* until after *throw* has formed selection and subcategorization relations with *to* and *the*, respectively. Now suppose that Tr does not have an EPP feature. The following derivation will then result:

- (19) 1. $R_{Sel}(\text{the, ball})$ the-ball
 2. $R_{Sel}(\text{throw, to John})$ throw-to John

3. $R_{\text{Sub}}(\text{throw, the})$ the-ball-throw-to John
4. $R_{\text{Mod}}(\text{perfectly, throw})$ perfectly-the-ball-throw-to John
5. $R_{\text{Sel}}(\tau, \text{throw})$ throw-perfectly-the-ball-<throw>-to John
6. $R_{\text{Agr}}(\tau, \text{the})$ same

At this point the remainder of the derivation is irrelevant, since the incorrect linear order of (18b) has already been produced. If, however, Tr has an EPP feature, then an occurrence of the ball will precede throw, followed by selection of τ by v and simultaneous replacement of \underline{y} by throw, producing (18a):

- (20) 7. $R_{\text{Sub}}(\tau, \text{the})$ the-ball-throw-perfectly-<the-ball>-<throw>-to John
8. $R_{\text{Sel}}(v, \text{throw})$ throw-the-ball-<throw>-perfectly-<the-ball>-
<throw>-to John

The existence of Tr and its associated EPP feature can thus be inferred indirectly in English through its effects on word order in PHON in sentences containing V-modifying adverbs.

2.1.3 The Semantic Interpretation of Tr and R_{Agr}

Before proceeding further, this is a good point at which to consider the semantic interpretation of Tr and its associated R_{Agr} relation. I will not attempt to specify formally the semantic content of τ , simply representing it as τ' at SEM. Informally, its content is suggested by notional terms such as ‘Patient’ (vs. ‘Agent’).²⁷ In any case, it is clear that τ' does not change the type of property expressions it applies to, since the predication operation turns transitive as well as intransitive VPs into propositions or propositional functions. Hence τ' must be of type $\langle \pi, \pi \rangle$. Thus F_1 maps the relation $R_{Sel}(\tau, see)$, where *see* itself has previously formed the relation $R_{Sub}(see, he)$, onto an expression of the following form at SEM: $\tau'(see'(he'))$, π .

Now consider the Agree relation. It is clear that Agree has no effect at all on semantic interpretation, nor does it have any effect on linear order. In fact, its sole effect at PHON is to induce morphological agreement between the phonetic realization of τ and some LI of category D and to assign accusative case to D. Intuitively, this seems to make sense, since the Agree relation neither alters function-argument structure in any way nor adds any lexical meaning: its only function is to “make visible” at PHON the transitivity relation between Tr and the nearest available LI of category D.

I assume that this analysis generalizes to all Agree relations, hence to the subject agreement relation to be discussed shortly. Thus the interpretation T' of an LI of

²⁷ There are scattered indications that Tr might also contain aspectual features, as suggested by the Scottish Gaelic data discussed in the text, cf. Ramchand (1997). However, such ideas are fairly speculative at this point.

category T is of type $\langle p, p \rangle$, which, when applied to the interpretation of a PrP, returns an expression of the form $T'(\dots)$ of type p. Similarly, the relation $R_{Agr}(\phi_T, \phi_D)$ has no effect at all on semantic interpretation. In PHON, however, R_{Agr} induces morphological agreement between T and the nearest matching D, as well as marking D with nominative case.

2.2 Clausality and Subject Agreement

I take up next a property that for lack of a better term I refer to as *clausality*. Clausality is reflected in the relation between the functional category T and some LI of category D within the category Pr which it selects. Clausality is to the type of propositions as transitivity is to the type of properties. Just as the relation of transitivity picks out some basic entity expression within a property expression and assigns it a special status as the “object,” so the relation of clausality picks out the external argument of a propositional function, or some other basic entity expression within PrP, and assigns it a special status as the “subject.” If Tr is not selected by Pr, the resulting sentence is intransitive.

Correspondingly, if a clause lacks T altogether (as happens, for example, if a verb selects Pr rather than T or C, or as also happens in adjuncts), the result is a so-called “small clause” (SC). Just as the minimal property is an intransitive verb, so the minimal proposition is a SC. If the argument of a property expression fails to form a relation with the category Tr, then it must form a relation with some other category instead. Likewise, if the argument of a propositional function fails to form a relation with T, then it must form a relation with some other category instead. In other words, transitive VPs and

clausal PrPs are “complete” in a certain sense, whereas intransitive VPs and bare PrPs (i.e. SCs) are “incomplete.”

I will assume that T consists of a complex of features, including tenseness, finiteness, and, optionally, a set of unvalued ϕ -features. The ϕ -features of T are valued by establishing an agreement relation with the nearest matching set of intrinsically valued ϕ -features belonging to an LI of category D and the Case feature of the latter is valued nominative by T at the same time. Structurally, then the relation between T and Pr is parallel to the relation between Tr and V. Likewise, the relation between the ϕ -features of T and the matching ϕ -features of a LI of category D is parallel to the relation between the ϕ -features of Tr and the matching ϕ -features of a LI of category D. This is shown in the following derivation, which is parallel to that in (14):

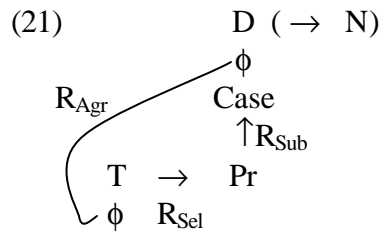

As we shall see shortly, however, if Pr does not happen to subcategorize a LI of category D, then the ϕ -features of T must be satisfied by forming a relation with the ϕ -features of the nearest available LI of category D. With these relations in place, we are now in a position to derive the essential syntactic, semantic and phonological properties of a wide variety of basic sentence types.

2.2.1 The Derivation of Unergative, Unaccusative, Transitive and Expletive Sentences

Let us start by considering the derivation of an unergative sentence such as *he will cough*. In this case, the light verb *v* in Pr subcategorizes a LI of category D which is semantically an argument. Hence the following nexus of relations will be formed:

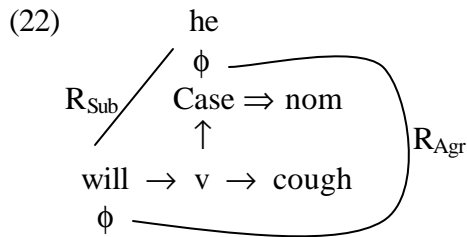

As is evident, the only available LI with ϕ -features matching those of *will* is *he*. Hence the relation R_{Agr} is established between *will* and *he*, followed by valuation of the ϕ -features of *will* and the Case-feature of *he*. At the same time, since T has an obligatory subcategorization feature in English, an occurrence of he must precede will in PHON.

The derivation thus proceeds as follows:

- (23)
- | | | |
|-----------------------------------------------------|------------------------------------------|----------------------------------------------|
| 1. $v'(\text{cough}'), \langle e, p \rangle$ | (v, cough) | cough- \langle cough \rangle |
| 2. $(v'(\text{cough}'))(\text{he}'), p$ | (v, he) | he/him-cough- \langle cough \rangle |
| 3. $\text{will}'(v'(\text{cough}'))(\text{he}'), p$ | (will, v) | will-he/him-cough- \langle cough \rangle |
| 4. same | $(\phi_{\text{will}}, \phi_{\text{he}})$ | will-he-cough- \langle cough \rangle |

Case

5. same (will, he) he-will-<he>-cough-<cough>

Semantic interpretation proceeds in tandem with the syntactic derivation, yielding ultimately a proposition of the form shown in step 5 of the derivation.

Consider next an unaccusative sentence such as *he will arrive*. The nexus of syntactic relations in this example is derived as follows:

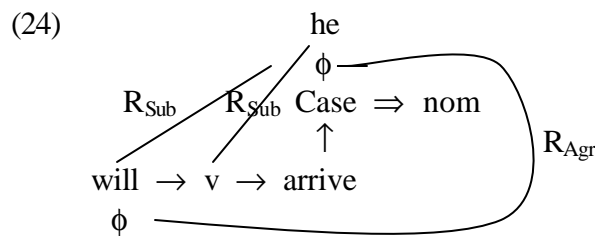

In this case, the D with matching ϕ -features closest to T is the LI *he* subcategorized by *arrive*. Hence the relation $R_{Agr}(\phi_{will}, \phi_{he})$ is formed, followed by valuation of the Case-feature of *he* as nominative. In addition, since both *v* and *will* have subcategorization features, an occurrence of he precedes *v* (which is itself replaced by an occurrence of arrive) and a second occurrence of he precedes will, resulting in the string he will arrive. Semantically, as discussed earlier, $arrive'$ is a property function of type $\langle u, \pi \rangle$, which combines with he' to form an expression $arrive'(he')$ of type π . *v* is thetic in this case, hence has the feature [-Cat], as does *arrive*. Therefore $arrive'(he')$ combines with v' to form a proposition of the form $v'(arrive'(he'))$, after which that expression in turn combines with $will'$ to form the proposition $will'(v'(arrive'(he')))$.

In contrast, consider a transitive sentence such as *he will see her*, which is derived as follows:

produce the incorrect string *her will he see. A possible answer to this question is provided by the RMLC formulated in the previous chapter. Since *she* was already subcategorized by *see* at the point in the derivation where T is looking for a LI to form a subcategorization relation with, the RMLC prevents *she* from being subcategorized again by T. The problem is that at this point in the derivation *he* also has already been subcategorized by *v*. Hence it would appear that the RMLC incorrectly prevents T from forming a subcategorization relation with either *he* or *she*. Suppose then we relax the RMLC, allowing *he* to be subcategorized by both *v* and *will* and at the same time allowing *she* to be subcategorized by both *see* and τ . This then raises a new question: why can't *v* form a relation with *she*, instead of forming a relation with the new LI *he*? In fact, nothing prevents this from happening. Suppose it does. The problem then is that because the Case-feature of the LI *she* has already been valued by Tr, *she* is inert and is therefore unable to form an R_{Agr} relation with the ϕ -features of T. Hence there is no way for the ϕ -features of T to be valued and the derivation crashes. These considerations strongly suggest that the RMLC is too strong, yet abandoning it totally leaves us with the problem we started out with, namely, why *will* must subcategorize *he* rather than *she*. I return to this problem after considering some further cases.

Consider now the derivation of an unaccusative sentence with expletive subject such as *there will occur an explosion*:

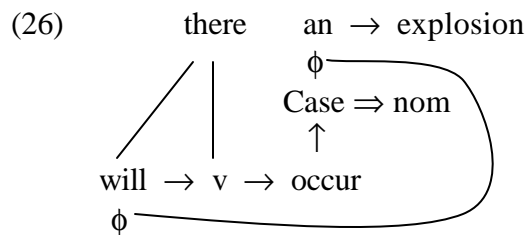

In this instance v has a subcategorization condition that must be satisfied, but because it does not require an argument semantically, it may be satisfied by forming a relation with the expletive *there*.²⁸ This, however, does not prevent *will* from forming an R_{Agr} relation with *an*, because *an* is the only LI with matching ϕ -features. We are still left with the problem of explaining why the subcategorization feature of *will* must be satisfied by forming a relation with *there* (assuming that *there* has a D feature), rather than with *an*. If the latter possibility were permitted, F_L would produce the incorrect string **an explosion will there occur*. But apart from this more general problem, which I return to shortly, the essential properties of expletive constructions fall into place without any special stipulations.

Consider, finally, impersonal transitives in Russian. As mentioned earlier, languages like Russian have examples such as (1e), for which there is no equivalent in English (e.g. **it killed the worker with a shard of concrete*, or the like). The reason is that in Russian “impersonal” v (i.e. a v with the feature [-Cat] whose translation is of type $\langle \pi, p \rangle$) can select Tr, whereas in English, impersonal v can only select V. Thus example (20e) would be derived as follows (ignoring for the sake of clarity the role of the instrumental phrase and also assuming that *rabocego* is headed by a null D element \mathcal{E}):²⁹

$$(27) \quad 1. \quad \emptyset'(\text{rabocego}'), u \quad R_{Sel}(\emptyset_D, \text{rabocego}) \quad \emptyset\text{-rabocego}$$

²⁸ See Bowers 2002, for arguments that expletives merge with v/Pr rather than with T.

²⁹ See Bowers 2002, for details, including an explanation of the initial position of the accusative Case-marked object.

2. $\text{ubit}'(\text{rabocego}')$, π $R_{\text{Sub}}(\text{ubit}', \emptyset_D)$ $\emptyset\text{-rabocego-ubit}'$
3. $\tau'(\text{ubit}'(\text{rabocego}'))$, π $R_{\text{Sel}}(\tau, \text{ubit}')$ $\text{ubit}'\text{-}\emptyset\text{-rabocego}\text{-}\langle\text{ubit}'\rangle$
4. same $R_{\text{Sub}}(\tau, \emptyset_D)$ $\emptyset\text{-rabocego-ubit}'\text{-}\langle\emptyset\text{-rabocego}\rangle\text{-}\langle\text{ubit}'\rangle$
5. $v'(\tau'(\text{ubit}'(\text{rabocego}')))$, p $R_{\text{Sel}}(v, \tau)$ $\text{ubit}'\text{-}\emptyset\text{-rabocego-ubit}'\text{-}\langle\emptyset\text{-rabocego}\rangle\text{-}\langle\text{ubit}'\rangle$
6. same $R_{\text{Sub}}(v, \emptyset_{it})$ $\emptyset_{it}\text{-ubit}'\text{-}\emptyset\text{-rabocego-ubit}'\text{-}\langle\emptyset\text{-rabocego}\rangle\text{-}\langle\text{ubit}'\rangle$
7. $\text{Past}'(v'(\tau'(\text{ubit}'(\text{rabocego}'))))$, p $R_{\text{Sel}}(\text{Past}, v)$ $\text{ubil-}\emptyset_{it}\text{-}\langle\text{ubit}'\rangle\text{-}\emptyset\text{-rabocego-ubit}'\text{-}\langle\emptyset\text{-rabocego}\rangle\text{-}\langle\text{ubit}'\rangle$
8. same $R_{\text{Agr}}(\phi_T, \phi_{\emptyset_{it}})$ $\text{ubilo-}\emptyset_{it}\text{-}\langle\text{ubit}'\rangle\text{-}\emptyset\text{-rabocego-ubit}'\text{-}\langle\emptyset\text{-rabocego}\rangle\text{-}\langle\text{ubit}'\rangle$

Because transitive verbs such *ubit'* in Russian have the option of selecting Tr, the Case feature of the internal argument is valued accusative by the probe in Tr, rendering its ϕ -features inaccessible to further operations, as discussed in the previous section. This in turn means that the ϕ -features of T can only be valued if a (null) 3rd person, singular,

neuter expletive form is subcategorized by v . In English, in contrast, a TrP can only be selected by a v that also requires an external argument.³⁰ Hence there are no impersonal transitive constructions in English.

2.2.2 *Passives and Middles*

I conclude this survey of basic sentence types by discussing briefly passive and middle constructions. It is argued in Bowers 2002 that passives and middles are like unaccusatives in lacking an external argument. They are different from unaccusatives in being transitive, which means that there is a Tr between Pr and V. Unlike transitives, however, passives and middles lack ϕ -features in Tr. The result is that the object of a passive, just like the internal argument of an unaccusative, must agree with the ϕ -features of T and be assigned nominative Case. Hence a passive sentence such as *he will be arrested* is derived as follows:

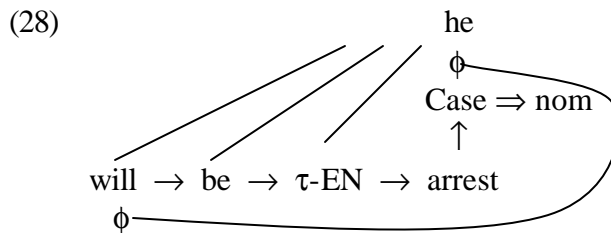

At PHON, occurrences of he will be placed successively to the left of arrest-EN, be and will, resulting in the string he will be arrested in PHON. As in the case of unaccusatives, however, the subcategorization (EPP) feature of Pr, lexically realized as *be*, *have*, or *get*

³⁰ In other words, only v [+Cat] can select Tr in English, whereas in Russian both v [+Cat] and v [-Cat] can select Tr.

in passives, can be satisfied by forming a relation with the expletive *there*, if it is available in the lexical array. In consequence, the phonetic form of an indefinite object such as *someone* will remain in its intermediate position to the left of Tr and to the right of be, while a copy of there will be placed to the left of will. However, *someone* still agrees with the ϕ -features of T and is therefore marked with nominative Case. The result is a sentence such as *there will be someone arrested*:

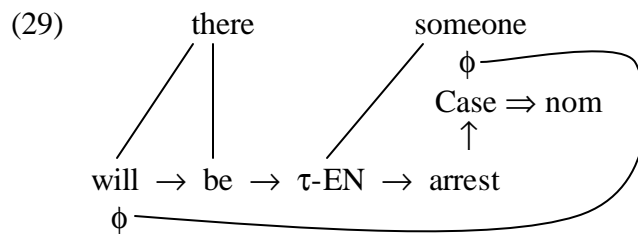

Middle sentences such as *the book reads well* are similar to passives in having a Tr that lacks ϕ -features. They differ, however, in lacking an overt realization of Pr, hence they end up looking just like unaccusatives in PHON, though they have many of the syntactic and semantic properties of transitives.

3 Reformulating the RMLC

Having analyzed a variety of basic sentence types in relational terms, I now return to the task of formulating a relational version of the MLC. I first recast the MLC as a very general constraint on derivations, concluding ultimately that such a constraint is still far too powerful. I then formulate an additional constraint on computations, which is

basically a generalization of Chomsky's (2000) Phase-Impenetrability Condition (PIC), and show that it is able to account for the data discussed so far.

3.1 *The Derivational Minimal Link Condition (DMLC)*

Our first attempt at formulating a relational version of the MLC in the previous chapter was based on the idea that a LI could not be the second coordinate in more than one relation of the same type. We saw, however, that this formulation was too strong, suggesting that it had to be weakened considerably, or perhaps abandoned entirely. Some support for the latter possibility was derived from the fact that at least some cases of overgeneration could be accounted for by independently needed restrictions at SEM. The cases just considered show that this conclusion also cannot be correct. In both transitive sentences such as (25) and expletive sentences such as (26), the subcategorization conditions in question have no reflex at SEM. Hence there is no way of ruling them out as violations of the legibility conditions at SEM. Another possibility, suggested in Chomsky (2000, 2001a), would be to link the possibility of an EPP feature to the Agreement relation. However, expletive sentences such as (26) show that this proposal also fails, since the D element with which *will* must form a subcategorization relation in this case is precisely *not* the one with which it forms an Agreement relation.

In theories that incorporate a level of constituent structure in NS, the MLC is standardly formulated in terms of some notion of distance based on the structural relation of c-command. In a relational theory of the sort that we are exploring here, however,

there is no such structural relation available. There is only one possibility: the MLC must reflect some property of derivations. Let us therefore examine the derivation of (26):

- (30)
1. $R_{Sel}(an, explosion)$ an-explosion
 2. $R_{Sub}(occur, an)$ an-explosion-occur
 3. $R_{Sel}(v, occur)$ occur-an-explosion-<occur>
 4. $R_{Sub}(v, there)$ there-occur-an-explosion-<occur>
 5. $R_{Sel}(will, v)$ will-there-occur-an-explosion-<occur>
 6. $R_{Agr}(\phi_{will}, \phi_{an})$ same

At this point in the derivation we have a choice of two continuations:

7. $R_{Sub}(will, there)$ there-will-e-occur-an-explosion-e_v
- *7.' $R_{Sub}(will, an)$ an-explosion-will-there-occur-e-e-e_v

The only discernible difference between these two continuations is that in 7 *will* has formed a subcategorization condition with the LI of category D most recently introduced

into the derivation, namely, *there* (at step 4), whereas in 7' *will* has formed a subcategorization relation with a LI of category D that was introduced into the derivation at a stage *before* the introduction of *there*, namely, at step 2.

It appears then that the RMLC must be a purely derivational constraint on syntactic computations of the following form:

(31) Derivational Minimal Link Condition (DMLC):

Suppose that a Locus λ is introduced into a derivation D at the i^{th} step of the derivation and that λ is searching for a LI α with which to form a relation $R(\lambda, \alpha)$. Then if there are two potential candidates α' and α'' , where α' was introduced at the $i-n^{\text{th}}$ stage of D and α'' at the $i-m^{\text{th}}$ stage, $n < m$, then the relation $R(\lambda, \alpha')$ must be formed.

The DMLC, thus formulated, requires that *will* form a subcategorization relation with *there*, which was introduced into the derivation at the fourth step of the derivation rather than with *an*, which was introduced at the second step of the derivation. The DMLC also works correctly in the case of a transitive sentence such as (25). At the stage of the derivation where *will* is searching for a LI with which to form a subcategorization relation, the LI *he* is “closer” in derivational terms than the LI *she*, since *he* was introduced into the derivation more recently than *she*.

Consider next the cases discussed in Chapter 2. Suppose the Locus is the complementizer *that* and it is searching for a LI of category T within the already formed network of relations underlying a phrase such as *Mary to say that John is nice*. The

reason *that* can't select the finite T of the complement clause is that the non-finite T *to* was introduced into the derivation more recently. Hence *to* must be chosen as the second coordinate of the selection relation with *that*: *(that, to). Since *to* fails to agree with *that* in finiteness and since the finite T in the complement is unavailable, the derivation crashes.

Consider finally a sentence such as *the girl's mother coughed*, changing the example used in Chapter 2 slightly, so as to avoid word order complications. Suppose that possessives in English are subcategorized by a null D \emptyset .³¹ Then such a phrase would be derived as follows:

- (32) 1. $R_{\text{Sel}}(\text{the}, \text{girl})$ the-girl
2. $R_{\text{Sel}}(\emptyset, \text{mother})$ \emptyset -mother
3. $R_{\text{Sub}}(\emptyset, \text{the})$ the-girl('s)- \emptyset -mother
4. $R_{\text{Sel}}(v, \text{cough})$ cough-<cough>
5. $R_{\text{Sub}}(v, \emptyset)$ the-girl('s)- \emptyset -mother-cough-<cough>

³¹ I assume that the LI \emptyset (in contrast to LIs such as *v* and *t*) has a phonetic form that can be “read” by the articulatory and perceptual components of SI. Specifically, it is interpreted as ‘no gesture’ and ‘silence’, respectively.

*5'. $R_{\text{Sub}}(\nu, \text{the})$ the-girl('s)- \emptyset -mother-cough-<cough>

Notice that in this instance it is unclear whether \mathcal{AE} or *the* is derivationally closer to the Locus ν , since both were most recently introduced at step 3 of the derivation. Hence it is not clear that the violation in 5' can be explained by the DMLC. This conclusion is reinforced by the observation that both the legitimate relation 5 and the illegitimate relation 5' have exactly the same output at PHON, suggesting that step 5' is not in fact a violation of the DMLC at all. The real problem is that if 5' is chosen instead of 5, then the phrase \mathcal{AE} *mother* will never be interpreted either as an argument of a predicate or as a predicate itself. Hence the derivation with 5' leads to a violation of the relational version of the θ -Criterion proposed in Chapter 1, one of the legibility conditions imposed on SEM by CI. Surprisingly, then, such derivations turn out to be irrelevant to the DMLC.

3.2 Reducing Accessibility

Even if the DMLC is correct, there must be some additional constraint that sharply limits the search space of FormRel. Otherwise, the entire derivation would have to be available each time FormRel applied—a computational nightmare. Chomsky (2000, 2001a) suggests that derivation must proceed by *phase*, a phase being a computational unit, some subpart of which becomes inaccessible to the computational mechanism once it has been constructed. The most natural way to define the notion phase in the relational theory proposed here is in terms of the Locus Principle. Let us suppose that certain LIs have the property that once they are saturated, some part of the derivation is automatically “sealed

off”, so that all of the LIs used up to that point are rendered inaccessible to any remaining operations in the derivation. We must now survey the derivations outlined in the preceding sections to see whether any obvious candidates for phasehood emerge. One thing that is immediately clear is that if λ_1 is a Locus and α is subcategorized by λ_1 , then both λ_1 and α must be available to the next Locus λ_2 that selects λ_1 . Thus both the subcategorized LI *he* and *v* in *he will cough* (see example (22) above) must be accessible to T, making it possible for *will* to select *v* and subcategorize *he*. Similarly, both *he* and *arrive* in the sentence *he will arrive* (see example (24)) must be accessible to *v*. This immediately suggests the possibility of adapting Chomsky (2000, 2001a) to the present framework in such a way that only the material *selected* by a phase-head is inaccessible, leaving the head itself and the material it subcategorizes still accessible to further operations.

Chomsky suggests that the two “propositional” categories *v* and C are the most natural candidates for phasehood. However, looking at the derivations discussed above, it seems that it might be possible to strengthen this hypothesis considerably.³² Suppose that *every* Locus with a subcategorized LI is in fact a phase in the sense just indicated. Then the PIC can be generalized in the following manner:³³

³² Dobashi (2003) argues that Chomsky’s notion of ‘phase’ plays a crucial role in determining phonological phrases, but not in determining linear ordering, consistent with the approach proposed here.

³³ A similar constraint, developed in somewhat different terms, has been proposed independently by Collins and Ura (2001:7).

(33) Relational Phase Impenetrability Condition (RPIC):

Let λ be a Locus, α a LI subcategorized by λ , and β a LI selected by λ . Then as soon as λ is saturated, β and all of the LIs that it selects or subcategorizes are inaccessible to any further selection or subcategorization relations. α and λ itself, on the other hand, remain accessible to further operations.

As each new Locus meeting the conditions in (33) is saturated, the RPIC automatically removes from the search space all but the Locus itself and the LI it subcategorizes, thus reducing the set of LIs that must be searched through by the next Locus to a bare minimum. It is important to note, however, that the RPIC, as stated here, does not apply to the Agreement relation (or, as will be seen in Chapter 5, to other “long distance” relations such as wh-Agreement), as is shown by the derivation of expletive sentences (cf. examples 26 and 29). To illustrate these points, consider derivation (26), for example. As soon as v is saturated by forming the relation $R_{\text{Sub}}(v, \text{there})$, all the material related to the V occur is “sealed off,” hence unavailable to form further relations. In particular, the D $a(n)$ is prevented from forming a subcategorization relation with *will*, leaving *there* as the only possible LI of category D with which *will* can form a subcategorization relation. However, the RPIC evidently does not prevent the ϕ -features of T from forming an Agreement relation with the ϕ -features and Case feature of $a(n)$.³⁴

³⁴ So far, the only constraint restricting the search space of the probes is the inertness principle, which dictates that an LI is rendered “inactive,” i.e. its ϕ -features are unavailable for further computation, as soon as its associated Case feature is valued. Thus in the derivation of the transitive sentence *he will see her* in (25), once the Case feature of *she* has been valued by forming a relation with the unvalued ϕ -features of Tr,

Suppose a LI λ_{n-1} selects a LI λ_n , which in turn subcategorizes a LI α . If λ_{n-1} has a subcategorization feature that could be satisfied by α , then the RPIC permits it to form the relation R_{Sub} with α . Suppose λ_{n-1} is in turn selected by λ_{n-2} and that λ_{n-2} also has a subcategorization feature that could be satisfied by α . If α were only subcategorized by λ_n , then it would be inaccessible to λ_{n-2} . However, since it has also established a subcategorization relation with λ_{n-1} , the RPIC will permit λ_{n-2} to form a subcategorization relation with α as well. The RPIC thus permits a LI to subcategorize a distant LI with the right properties, but only if the two LIs are connected to one another by a continuous “path” of intermediate selection and subcategorization relations, in the manner shown schematically below:³⁵

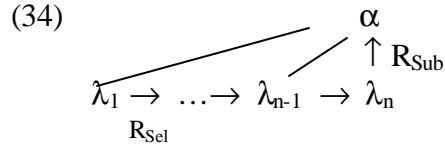

For example, in the derivation of the passive sentence *he will be arrested*, shown in (28), the internal argument of *arrest* is subcategorized successively by *arrest*, τ , *be*, and *will* without violating the RPIC. However, as soon as the intermediate LI *be* subcategorizes the expletive *there* in (29), *he* is immediately sealed off and prevented from forming further subcategorization relations. Thus the only LI available to satisfy the subcategorization features of *will* in this case is *there*. As noted above, however, the

its associated ϕ -features are no longer available to enter into another Agreement relation, for example, with the ϕ -features of *will*. Whether the search space of the probes is also constrained by a principle similar to the RPIC is a question that will be addressed in the next chapter.

³⁵ This characterization of the effects of the RPIC will be refined slightly in the next chapter.

RPIC does not prevent the LI *he* from forming an Agreement relation with the ϕ -features of *will* in both cases. This formulation of the RPIC will be further refined in the next two chapters.

Chapter 4

Syntactic Computation: Raising and Obligatory Control

It was shown in the preceding chapter that the existence of the relation R_{Agr} can be explained as the optimal solution to the problem of representing non-local relations such as transitivity and clausality in PHON. Specifically, it was shown that if a V is not “closed off” by a LI of category Tr with ϕ -features, then the Case-feature of the internal argument of V must be valued by the next available probe with ϕ -features that match those of the internal argument. If V is contained in a finite clause, then the ϕ -features of T will match those of the internal argument, as is the case, for example, in finite unaccusative and passive sentences. There are, however, two possible subcases: Tr may be lacking altogether or, alternatively, Tr may be present but lack ϕ -features. An example of the first subcase is an unaccusative sentence; an example of the second subcase is a passive sentence.

In this chapter I shall be concerned with the analogous question at the clause level: what happens if PrP is not “closed off” by a category T with ϕ -features? Here also there are two subcases: there may be no LI of category T at all, as in the case of SC complements and adjuncts, or T may simply lack ϕ -features, as in the case of non-finite complements in English. In either instance, the Case-feature of the relevant LI of

category D must be valued by a “higher” probe with matching ϕ -features. I shall argue that the basic properties of raising and obligatory control constructions with both infinitival and SC complements follow directly from the principles already at our disposal. I start by examining raising and obligatory control in infinitive complements and then turn to a variety of SC constructions.

1 Obligatory Control and Raising in Infinitive Complements

For reasons that will soon become apparent I take up obligatory control constructions first, after which I discuss raising constructions.

1.1 Obligatory Control(OC)

Let us start by considering the derivation of a sentence such as *she persuaded him to sing*. *Persuade* is a transitive verb that selects the T element *to* and subcategorizes a D element such as *he/him*. Hence the following network of relations will automatically be formed:

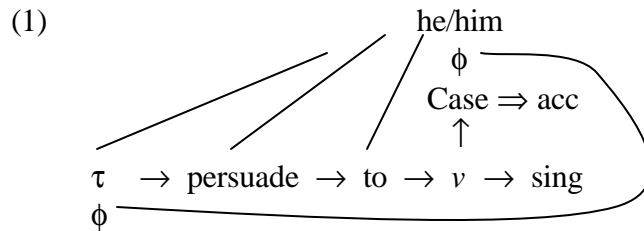

Notice that given our assumptions, the derivation shown in (1) is the null hypothesis. It would take some stipulation to the contrary to *prevent* the lexical item *he/him* from

forming relations successively with *v*, *to*, *persuade*, and *t*.³⁶ On minimalist grounds, it would have to be shown that any constraint on FormRel departing from the null hypothesis is principled, i.e. based on conditions of computational efficiency and interface conditions or on general properties of organic systems.³⁷ In the framework proposed here, it is hard to see how such a constraint on FormRel could be principled. In fact, just the opposite is true, as can be seen by considering what happens if an independent D such as *she/her* forms a relation with *persuade*:

³⁶ Chomsky (2000: 103) suggests that the step in (1) that forms the relation $R_{\text{Sub}}(\text{persuade}, \text{he/him})$ is ruled out by the following principle:

- (i) Pure Merge in θ -position is required of (and restricted to) arguments.

He argues that (i) is “implicit in the conception of θ -roles as a relation between two syntactic objects, a configuration and an expression selected by its head.” Furthermore, his assumption that Move is always contingent on an Agree relation, which in turn is contingent on the presence of an EPP feature, guarantees that Move is only permitted to non- θ positions. Hence (i), together with his theory of Move, in effect incorporates the Chain Condition into the minimalist framework by virtue of the distinction between ‘pure’ Merge and Merge of a copy (or in the terminology of Chomsky 2001b. *external* and *internal* Merge). However, even in Chomsky’s own theory, it is not so clear, given the copy theory of movement (or the more recent occurrence theory of movement), that such a distinction is justified. In the framework proposed here, it is clear that the distinction is unmotivated. See Bowers 2001b, for further discussion.

³⁷ Chomsky (2001b) suggests that there is justification for departing from the null hypothesis, namely, the expectation that the two kinds of semantic conditions at SEM (i.e. argument structure and “everything else”) should correlate with the two kinds of Merge. However, as has been argued here at length, all of the relevant operations correlate with function-argument structure at SEM and, as will be shown shortly, the equivalent of internal Merge in non-argument positions is actually motivated by properties of PHON rather than properties of SEM.

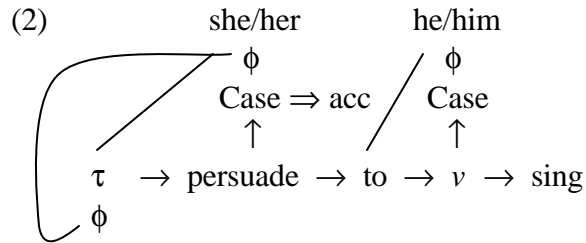

Let us assume, following the discussion at the end of Chapter 3, that the probe in Tr can find matching ϕ -features in either of the LIs *she/her* or *he/him*. Regardless of which of the two is valued, there will be no way for the Case feature of the other to be valued. Hence the derivation crashes, explaining the ungrammaticality of sentences such as **we persuaded her him to sing*. In derivation (1), in contrast, the only LI with ϕ -features that match the probe in Tr is *he/him*. Its Case feature is therefore valued accusative and the derivation converges, producing the transitive VP *persuade him to sing*.

Consider next the representation of (1) at SEM. Verbs such as *persuade*, as shown in the preceding chapter, are of type $\langle p, \langle u, \pi \rangle \rangle$. As has just been shown, both *persuade* and $v(+sing)$ must establish the relation R_{Sub} with the LI *he*. Hence he' must be an argument of both v' and $persuade'$ at SEM, resulting in the following representation: $(persuade'(to'(v'(sing')))(he'))(he')$, in which the entity expression he' functions correctly as an argument of both $(v'(sing'))$ and $persuade'$.

We have thus derived the essential syntactic and semantic properties of transitive OC constructions from the basic principles assumed here without having to assume, as in the standard theory of OC constructions, an entirely new relation of “control” and an entirely new entity PRO with unique distributional and Case-marking properties. As argued in Bowers 2001b (following earlier arguments in Bowers 1973, 1981, Bowers and Reichenbach 1979), this provides an extremely strong argument in support of a

derivational theory of interpretation, since only in such a theory is it possible to avoid this unnecessary proliferation of entities and operations.

The derivation and interpretation of an intransitive OC sentence such as *he tried to sing* is exactly analogous, except that there is no Tr because *try* is intransitive. Hence a copy of the subject of the infinitive complement is eventually spelled out at PHON to the left of T in order to satisfy its subcategorization feature. At the same time, its Case feature is valued by the probe in T³⁸:

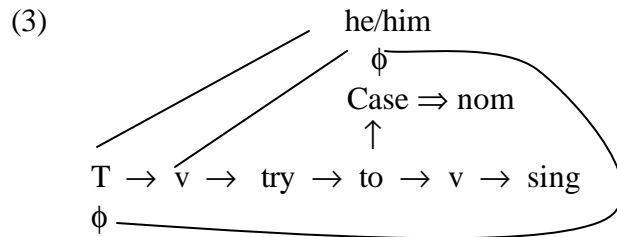

Turning to semantic interpretation, the predicate try' is of type $\langle p, \pi \rangle$ and v' is of type $\langle \pi, \langle u, p \rangle \rangle$. Therefore when the relation $R_{\text{Sub}}(v, \text{he})$ is formed, it is correctly interpreted as $(v'(\text{try}'(\text{to}'(v'(\text{sing}')))(\text{he}')))(\text{he}')$, with the entity expression he' being interpreted as an argument of both $(v'(\text{sing}'))$ and of $(v'(\text{try}'))$.

Before turning to raising/ECM constructions, one important feature of the derivation in (3) needs to be discussed. Note that the LI *try* is simply “skipped over” in the sequence of subcategorization relations: (to, he), (v, he), (T, he). This is permitted by

³⁸ In the minimalist analysis of OC proposed in Bowers 2001b, it was assumed that each of the intermediate copies of the infinitival subject had an unvalued Case feature, all of which were valued simultaneously when the Case feature of highest copy in Spec,Pr was valued. In the relational theory proposed here, this assumption is no longer necessary, since copies are present only in PHON. Hence the probe in T need only form an R_{Agr} relation with the goal in *he/him* and value its Case feature once, a considerable simplification.

the RPIC, as formulated at the end of Chapter 3, because *try* is not a phase. By definition, a phase consists of a Locus λ , a complement β , and a subcategorized LI α . Since *try* has no subcategorization feature, it is not a phase. Hence its complement is not rendered inaccessible by the RPIC and the LI subcategorized by *to* is still available to form a relation with the next Locus ν .

1.2 Raising

Consider next the superficially similar raising/ECM sentence *we expect him to sing*. The verb *expect* differs from *persuade* precisely in *not* having a subcategorization feature that needs to be satisfied. It must, however, be selected by Tr because it is transitive (see Bowers 2002, for arguments). Hence it will automatically be derived as follows:

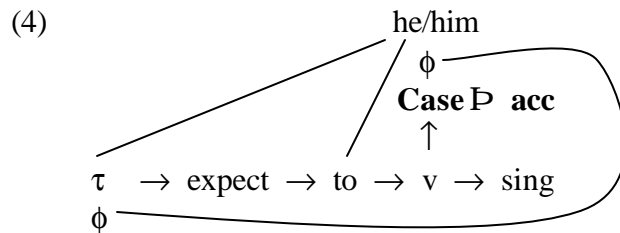

Once again, since the closest D element with ϕ -features matching those in Tr is *he/him*, the accusative case phonetic form him is spelled out in PHON. At the same time, *he/him* is the nearest LI of category D that can satisfy the EPP feature of Tr. Hence an occurrence of the phonetic form of *he/him* must appear to the left of τ in PHON, even though it is syntactically the subject of the complement clause and has no syntactic or semantic relation at all to the verb *expect*. Note that since *expect*, just like *try*, does not have a subcategorization feature, it is not a phase. It may therefore select *to*, and

subsequently be selected by Tr, without *he/him* being rendered inaccessible to Tr by the RPIC. The representation at SEM operates in parallel fashion. Since expect' is of type $\langle p, \pi \rangle$, the interpretation of (4) is completely different from that of (1):

$\text{expect}'(\text{to}'(v'(\text{sing}'))(\text{he}'))$, with he' functioning only as an argument of $v'(\text{sing}')$ at SEM, not as an argument of expect' .

An intransitive raising sentence such as *he seems to sing* is derived in completely parallel fashion, except in this case there is no Tr, since *seem*, like *try*, is an intransitive verb:

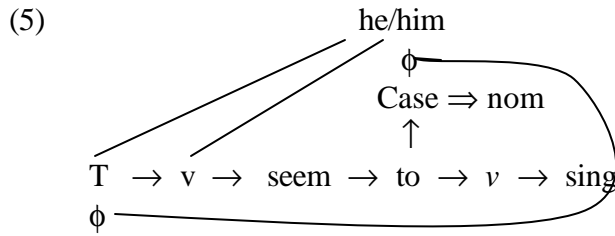

(Once again, *seem* can be “skipped over,” since it is not a phase.) Similarly, since seem' is of type $\langle p, \pi \rangle$ and v' is of type $\langle \pi, p \rangle$, the entity expression he' is interpreted only as an argument of $v'(\text{sing}')$, not as an argument of the matrix verb $v'(\text{seem}')$, yielding the correct interpretation $v'(\text{seem}'(\text{to}'(v'(\text{sing}'))(\text{he}')))$.

In summary, then, the basic syntactic and semantic properties of OC and raising/ECM verbs can be derived from the principles proposed here without having to assume an entirely different syntactic mechanism of “control” for the former, together with an entity PRO with unique distributional and Case properties. From the point of view of a fully derivational theory of interpretation, the necessity for Control Theory and PRO is simply an artifact of a theory that assumes a principle equivalent to (i) in footnote 1, arbitrarily ruling out the possibility of establishing an “interpretable” subcategorization

relation more than once in a given derivation. I show next that precisely parallel phenomena occur in constructions with SC complements.

2 Obligatory Control and Raising in SC Complements

The second way in which PrP may fail to be “closed off” is for the category T to be absent altogether. The result is a bare PrP, which, as argued in Bowers (1993, 1997, 2001a, 2002), is the formal representation of a “small clause” (SC). If the theory proposed here is correct, then we would expect to find SC constructions corresponding to transitive and intransitive OC complements, on the one hand, and to transitive and intransitive raising/ECM complements, on the other. (6a-b) exemplify the former, while (7a-b) exemplify the latter:

(6) a. That makes me sad.

b. I feel sad.

(7) a. They consider him tall.

b. He seems tall.

I will discuss only the transitive examples (6a) and (7a), leaving the reader to work out the analysis of the intransitive examples.

Consider first example (6a). I assume that *make* may have a selection feature [$_\text{Pr}$] and an interpretable subcategorization feature [$_\text{D}$]. I assume in addition that

there is a LI \mathcal{AE} of category Pr that selects LIs of categories A, P, and N. Unlike the LI v , which selects LIs of category V, \mathcal{AE} is phonetically interpretable (see footnote 13 of Chapter 3). This accounts for the fact that A, P, and N do not “raise” in English.³⁹ I also assume, to simplify the exposition, that all nonverbal predicates are unergative, hence selected by \mathcal{AE} .⁴⁰ Given these assumptions, a (partial) derivation of the following sort will automatically be produced:

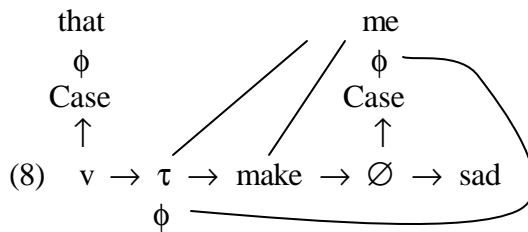

Corresponding to these operations, the following sequence of strings will be produced at PHON: \emptyset -sad, I/me- \emptyset -sad, make-I/me- \emptyset -sad, I/me-make-<I/me>- \emptyset -sad, make-I/me-<make>-<I/me>- \emptyset -sad, me-make-<me>-<make>-<me>- \emptyset -sad, make-me-<make>-<me>-<make>-<me>- \emptyset -sad, that-make-me-<make>-<me>-<make>-<me>- \emptyset -sad. On the semantic side (ignoring a few details), \emptyset' is of type $\langle \pi, \langle u, p \rangle \rangle$, make' is of type $\langle p, \langle u, \pi \rangle \rangle$, and v' is of type $\langle \pi, \langle u, p \rangle \rangle$. Hence the resulting interpretation is of the following form: $((v'(\text{make}'(\text{sad}'(I'))))(I'))(\text{that}')$. As is evident, the derivation is completely parallel to (1), the only difference being that the complement in this case is a PrP rather than a TP.

³⁹ It is argued in Bowers (1993, 2001a) that Pr may also be realized in English by the LI *as*. See Bowers 2001a, for a short survey of the different morphological forms that Pr may take in a number of different languages.

features. They differ only in the kinds of features for which they are searching, the selectors characteristically searching for grammatical category features and the probes for ϕ -features. I shall therefore first reconsider the evidence that seems to support the view that Agreement does not fall under the RPIC. I then propose a reformulation of the RPIC that permits a unified statement of the reduction of search space for the formation of both selection/subcategorization relations and Agreement relations.

Recall that the main argument for excluding Agreement relations from the purview of the RPIC is the fact that though an expletive prevents a new Locus from forming a subcategorization relation with any previously subcategorized LIs, it clearly does not prevent a probe from finding a goal in one of these same LIs. Thus consider derivation (26) from Chapter 3 (repeated below and renumbered as (12)):

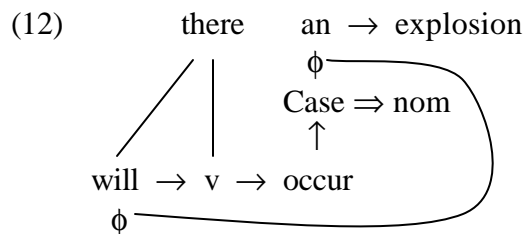

As was shown in Chapter 3, as soon as v forms a subcategorization relation with *there*, the D *an* is no longer available to form a subcategorization relation with the new Locus *will*, whereas in the non-expletive sentence *an explosion will occur*, it is available. The presence of *there*, on the other hand, does not in the least prevent the probe in *will* from finding a goal in *an*. Let us suppose, following Bowers (2002: 197), that the real reason *there* does not prevent an Agreement relation from being formed between the ϕ -features of *will* and the ϕ -features of *an* is simply that *there* lacks ϕ -features of its own. In other

words, only the introduction of an LI *which itself has f-features* is capable of rendering a previously introduced LI with ϕ -features inaccessible to any probes that are later introduced into the derivation. That this is the correct approach is strongly suggested by the derivation of a transitive sentence such as (25) in Chapter 3 (repeated below and renumbered as (13)):

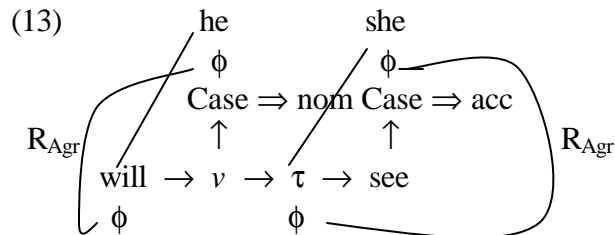

As is immediately evident, as soon as v forms a subcategorization relation with the LI *he*, which has ϕ -features of its own, the previously introduced LI *she* is no longer accessible to the probe in *will*, suggesting that the introduction of a new subcategorized LI with ϕ -features renders the previously introduced one inaccessible. However, this conclusion is obscured by the fact that the disallowed derivation can, in this instance, be ruled out by other independently needed principles. As soon as the probe in Tr in (13) forms an Agreement relation with the goal in *she*, the latter becomes “inert,” hence unavailable to form any further Agreement relations. Thus the only remaining LI in which the probe in *will* can search for a goal is *he*. Suppose, on the other hand, that the probe in *will* in (13) did form an Agreement relation with the goal in *she*. This would then leave no probe available to form an Agreement relation with the ϕ -features of *he*, hence its Case feature would be unvalued and the derivation would crash. At the same time, the ϕ -features of Tr would remain unvalued, providing another reason for the derivation to crash. In short,

it appears that it is simply unnecessary to extend the RPIC to Agreement relations, because there are other principles available that are capable of doing the job.

However, we have so far only looked at the simplest cases. Given the analysis of OC constructions proposed in this chapter, we are now in a position to show that there are in fact more complex cases where the inertness principle alone will not suffice. In such cases, only an extension of the RPIC to Agreement is sufficient to rule out impossible derivations. Consider then the following derivation of the sentence *she persuaded him to sing*:

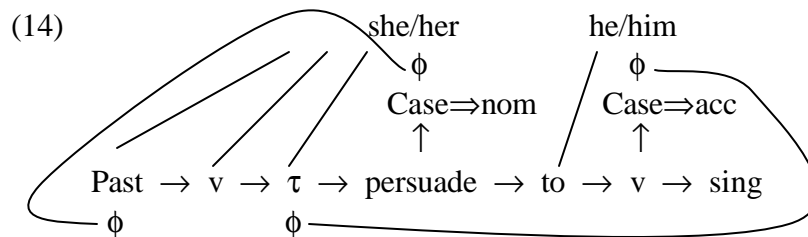

Here accusative Case is assigned to *he/him*, producing the phonetic form him, while nominative Case is assigned to *she/her*, producing the phonetic form she. *He/him* is interpreted as the sole argument of *v+sing*, while *she/her* is interpreted as both the subject and object of *v+persuade*. If the only principle limiting the search space of the probes were inertness, this derivation would be perfectly legitimate, resulting in the string she-Past-persuade-him-to-sing with an interpretation of the form “she persuaded herself for him to sing,” or the like. Obviously, no such derivation is possible in English. If, however, the presence of the LI *she/her* were able to block access of the probe in Tr to *he/him*, then this derivation would crash because the Case feature of *he/him* would never be valued. This in turn would leave (1) as the only possible way to derive the string in question.

These observations suggest that just as forming a subcategorization relation between a Locus and an LI of category D immediately renders any subcategorized LIs of category D in the complement of that Locus inaccessible to the selectors of the next Locus, so the presence of a subcategorized LI with Case and Agreement features renders any subcategorized LIs with Case and Agreement features in the complement inaccessible to a probe in the next Locus to be introduced. Schematically, these two constraints can be visualized as in (15a,b):

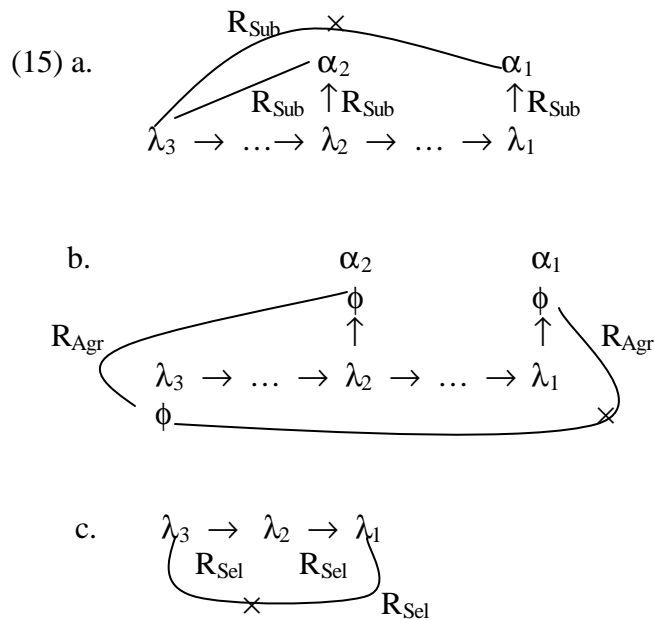

In (15a), given a choice between the two subcategorized LIs α_1 and α_2 , a new Locus λ_3 must form the relation $R_{\text{Sub}}(\lambda_3, \alpha_2)$. Similarly, in (15b), as has just been shown, λ_3 must form an R_{Agr} relation with the ϕ -features of α_2 rather than with those of α_1 . Finally, to complete the picture, (15c) shows a Locus λ_3 may not select a LI that has already been selected earlier in the derivation.

Notice that all three of the constraints in (15) fall under the purview of the DMLC, as broadly formulated in Chapter 3. Suppose that λ is a Locus seeking to form a relation R with some LI or a set of features within a LI. Suppose furthermore that there are two LIs α_1 and α_2 , previously introduced into the derivation, both of which meet the conditions required by λ , and that α_2 was introduced into the derivation more recently than α_1 . Then the relation $R(\lambda, \alpha_2)$ must be formed.

If, however, we look at these constraints in terms of accessibility, (15a) and (15b) are quite different in character from (15c). As soon as an LI λ_1 is selected by λ_2 , λ_1 immediately becomes inaccessible to any further selection relations. (I refer to this constraint henceforth as the *Selection Condition (SC)*.) In contrast, a subcategorized LI α_1 remains accessible to other subcategorization relations indefinitely (and, as has been shown in this chapter, can enter into an indefinite number of subcategorization relations) until another LI α_2 is subcategorized, at which point it immediately becomes inaccessible to further subcategorization relations. Similarly, the Case and ϕ -features of an LI α_1 remain accessible indefinitely until another LI α_2 with matching ϕ -features is introduced into the derivation, at which point they also become inaccessible to any probes that are subsequently introduced.⁴¹ (Henceforth I refer jointly to these constraints on subcategorization and agreement as the *Accessibility Condition (AC)*.)

⁴¹ As we have already seen, Case and ϕ -features are also rendered inaccessible by virtue of forming an Agree relation with a matching set of unvalued ϕ -features. This is a separate constraint which I refer to, following recent usage, as the *Inertness Constraint (IC)*.

Finally, let us recall at this point the constraints that govern accessibility to modification. It was shown in Chapter 2 that a single LI can be modified by an indefinite number of modifiers. (Modification is similar to subcategorization in this respect, since a single D can be subcategorized by an indefinite number of Loci.) However, as soon as a modified LI is selected by another LI, it is no longer accessible to modification. Hence any explanation of the SC will immediately explain this constraint on modification as well.

4 The Selection Condition and the Accessibility Condition

I conclude this chapter by showing that the SC is a totally different kind of condition from the AC. I shall show that the SC is not in fact an independent condition at all, but rather falls out of the legibility conditions at SEM. The AC, in contrast, is a pure economy condition whose function is to limit the computational complexity of syntactic derivations.

4.1 The Selection Condition

Consider the following partial derivation of the phrase *kiss him*:

- | | | | |
|---------|------------------------------------|-----------------------------|---------------------------------------------|
| (16) 1. | $\text{kiss}'(\text{him}')$ | $(\text{kiss}, \text{him})$ | him-kiss |
| 2. | $\tau'(\text{kiss}'(\text{him}'))$ | (τ, kiss) | $\text{kiss-him-}\langle\text{kiss}\rangle$ |

3. same (τ, him) him-kiss-<him>-<kiss>
4. $v'(\tau'(\text{kiss}'(\text{him}')))$ (v, τ) kiss-him- <kiss>-<him>-<kiss>

Since v subcategorizes either Tr or V, at step 4. of the derivation we could instead form the pair (v, kiss) . F_1 would then produce the semantic representation: $v'(\text{kiss}'(\text{him}'))$. Notice, however, that there is no way of integrating this piece of interpretation with the piece produced by steps 1-3, given the principles of interpretation we have assumed. Hence we would be left at the end of the derivation with two unrelated bits of interpretation, a violation of the general principle of compositionality. It is easy to see that any attempt to select a LI that has already been selected previously in the derivation will lead to a violation of compositionality of exactly the same kind. I conclude that there is no need to treat the SC as a condition on syntactic derivations, since all such derivations will be uninterpretable at SEM.⁴²

4.2 The Accessibility Condition

Having explained the SC as a violation of legibility conditions at SEM, we can now focus on providing a unified statement of the AC. As already noted, constraints (15a,b) are

⁴² It is interesting to note that the result at PHON of forming the ordered pair (v, kiss) is perfectly well-formed and is in fact identical to the output of step 4 of (16), reinforcing the idea that the SC is a purely semantic constraint.

obviously similar in form. Furthermore, it is clear that neither constraint has anything to do with ill-formedness at SEM. This is obvious in the case of (15b) because R_{Agr} has no effect on interpretation. As for (15a), though there are cases, as shown in this chapter, where copying an LI is accompanied by an interpretive effect, there are many other cases where displacement has no effect at all on SEM. Consider, for example, derivation (30) in Chapter 3 (repeated below, for convenience):

- (17)
1. $R_{Sel}(an, explosion)$ an-explosion
 2. $R_{Sub}(occur, an)$ an-explosion-occur
 3. $R_{Sel}(v, occur)$ occur-an-explosion-<occur>
 4. $R_{Sub}(v, there)$ there-occur-an-explosion-<occur>
 5. $R_{Sel}(will, v)$ will-there-occur-an-explosion-<occur>
 6. $R_{Agr}(\phi_{will}, \phi_{an})$ same
 7. $R_{Sub}(will, there)$ there-will-<there>-occur-an-explosion-<occur>
 - *7.' $R_{Sub}(will, an)$ an-explosion-will-there-occur-<an-explosion>-<occur>

Neither the good derivation ending with step 7. nor the bad derivation ending with step 7.' has any effect on semantic interpretation. Hence the contrast cannot be due to legibility conditions at SEM.

Nor can the contrast be explained in terms of legibility conditions at PHON. There is no purely phonetic reason (independent of the syntactic derivation) why the linear ordering in 7. should be preferred to that in 7.' Given the availability of multiple occurrences of phonetic forms of LIs at PHON, neither representation violates linear ordering. Similarly, there is no purely morphological or phonetic reason why a sentence such as **him will kiss her* should not exist. Hence neither constraint (15a) nor constraint (15b) can be explained as violations of legibility conditions at PHON.

There is only one possibility left: the AC must be a purely syntactic constraint, limiting the computational complexity of derivations. As argued earlier, the most natural way to think of such a condition is in terms of accessibility. Let us therefore formulate the condition in the following way:

(18) Accessibility Condition:

Let (α, β) be an ordered pair of LIs, such that $(\alpha, \beta) \in R_{\text{Sub}}$ and β contains a feature F .⁴³ Then F is accessible until a new ordered pair (α', β') is formed, such that $(\alpha', \beta') \in R_{\text{Sub}}$, $\alpha \neq \beta'$, $\beta \neq \beta'$, and β' contains F .

⁴³ For the sake of clarity, I simplify the statement of the condition by referring to a single feature F , rather than to some relevant subset of the features contained in β , as would normally be required, e.g. the subset of ϕ -features, of grammatical category features, etc.

Stated in this fashion, the AC now covers all the cases discussed so far. In particular, a subcategorized LI will be available to form (any number of) new subcategorization relations until a subcategorization relation is formed between a new pair of LIs drawn from the lexical array. At that point, the LI that was subcategorized first becomes completely inaccessible, which means that it is no longer in the search space of FormRel. Obviously, this reduces significantly the computational burden on FormRel. At the same time it permits, within certain limits, indefinitely long sequences of subcategorization relations, which results in the appearance of long-distance “displacement” at PHON. If the subcategorized LI contains Case and Agreement features, these too will continue to be available, even if new subcategorization relations are formed, until either a new subcategorization relation is formed with an LI that has Case and Agreement features itself or until the Case feature is valued (the IC). Hence “long distance” Agreement relations are also tolerated, as long as the relation is not disrupted by another relation of the same kind.

Chapter 5

Operators

I conclude this work by showing that the theory developed in the preceding chapters can be extended to cover the various processes involved in the formation of operator constructions. I first analyze question formation within single root clauses and WH-complements, demonstrating that apparent instances of head movement and constituent movement can once again be derived from the basic syntactic relations of selection and subcategorization, together with legibility conditions at PHON. I then argue that a separate relation of wh-agreement is needed and show that many well-known constraints on movement in complex sentences can be derived from the Inertness Condition, together with minimal legibility conditions governing operator constructions at SEM.

1 Selection: Auxiliary Inversion and “Do-Support”

Let us start by comparing the formation of questions in English in root clauses and WH-complements with respect to the relation of selection. As is well-known, auxiliary verbs in English must appear before the subject of yes/no questions in root clauses, but not in WH-complements:

- (1) a. Will/did/does he scream?

b. *Whether/if he will scream/screamed/screams.

(2) a. I wonder whether/if he will scream/screamed/screams.

b. *I wonder will/did/does he scream.

I propose to account for this complementary distribution in the following way. Let us assume that among the LIs of category *C* are *if*, *whether*, and *Q*. Verbs such as *wonder*, *ask*, *doubt*, etc. may select *if* or *whether*, but not *Q*. *Q*, on the other hand, may appear optionally in root clauses, but not *whether* or *if*. This will produce derivations of the following sort:

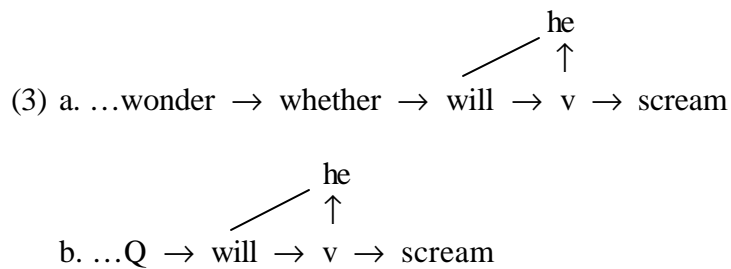

Applied to (3a), the linearization function F_L automatically produces the correct order in PHON: ...wonder-whether-he-will-<he>-scream-<scream>. But what about (3b)? Let us assume that *Q*, like *v* and τ , has no phonetic form of its own. Then by (12), in the first chapter, F_L must provide *Q* with an occurrence of the phonetic form of the LI it selects, in this case will. This results in the correct order at PHON: will-he-<will>-<he>-scream-<scream>. The appearance of I-to-C movement in the syntax can thus be explained, as have other apparent instances of head movement, by the interaction of the linearization function with the legibility conditions at PHON.

We are still left, however, with the problem of explaining the appearance of the auxiliaries *does/did* in simple Present/Past tense forms of (1a). Let us assume that the category T can be realized by the features [+/-Pres]. Furthermore, let us assume that though these features are not interpretable at PHON by themselves, they can be transformed by regular morphophonemic rules of English into “readable” phonetic forms when they immediately precede the phonetic form of a verb. In a non-question form such as *he screams*, for example, the substring [+Pres]-scream will be turned into the phonetic form screams.⁴⁴ Now suppose that in the question form the feature [+/-Pres] replaces Q in the phonetic form of a simple present or past tense question, just as the phonetically interpretable auxiliary *will* did in (3b):

(4) [+Pres]-he-<[+Pres]>-<he>-scream-<scream>

The result is that the only pronounceable occurrence of the feature [+Pres] no longer immediately precedes the phonetic form of a verb. Hence the output of F_L in this case is “unreadable” and it would therefore appear that the derivation must crash.

However, following in essence the earliest analyses of the English auxiliary system (Chomsky 1955, 1957), I propose that in this situation the phonetic form (4) can be rescued as a “last resort” by inserting the phonetic form of the verb *do* to the right of the feature [+Pres]:

⁴⁴ To ensure that the morphophonemic rules apply correctly, it may be necessary to assume that category features are carried over into the output of F_L. Alternatively, the morphophonemic rules may be

(5) [+Pres]-do-he-<[+Pres]>-<he>-scream-<scream>

The substring [+Pres]-do is then assigned the phonetic form does by the morphophonemic rules of English, resulting finally in the correct phonetic form does he scream.

Clearly, this process of “Do-Support” that “rescues” question forms such as (4) is highly language-specific. Hence it is not surprising that it is part of the morphophonemic system that adjusts the output of F_L , in order to make it “readable” to SI. In fact, given the highly constrained syntactic theory proposed here, this is the only possible way of describing the formation of simple present and past tense question forms in English. We have thus derived Chomsky’s classic account of Do-Support as a theorem from basic principles.

2 Wh-subcategorization

Having accounted for the basic properties of yes/no questions, let us next look at the behavior of simple *wh*-questions in root clauses and WH-complements:

- (6) a. Which book did he read?
 b. *Which book he read?
 c. *Did he read which book?

incorporated into the operation of F_L .

- (7) a. *I wonder which book did he read.
 b. I wonder which book he read.
 c. *I wonder did he read which book.

(6) shows that in root clauses both the displacement of the *wh*-phrase to initial position and inversion of the auxiliary are obligatory; (7) shows that in WH-complements, in contrast, displacement of the *wh*-phrase is obligatory, while inversion of the auxiliary is impossible. It follows that displacement of the *wh*-phrase cannot be dependent on the presence of Q, since WH-complements never have Q. Let us assume therefore that there is a feature [+wh] in C that is obligatory WH-complements and optional in root clauses.⁴⁵ The phonetic form of [+wh] is Q in root clauses and ∅ in WH-complements.

The fact that the phonetic form of the *wh*-phrase shows up at PHON to the left of the auxiliary in root clauses strongly suggests that there must be a kind of subcategorization relation between [+wh] and *which book*. Furthermore, this new kind of subcategorization feature is clearly “uninterpretable,” just like the one associated with T, since the position to its left is not an argument position at SEM. It follows immediately from the principles already at our disposal that an occurrence of the phonetic form of *which book* must be placed to the left of the phonetic form of *did* at PHON. Henceforth I refer to this relation as *wh*-subcategorization.

Notice that the *wh*-subcategorization feature of [+wh], like the subcategorization feature of T, is subject to parametric variation, since there are languages like Japanese, Chinese, etc. that never have displaced *wh*-phrases. However, *wh*-subcategorization

⁴⁵ This accounts nicely for the fact echo questions are possible in root clauses, but not in WH-complements: *he read which book?*, **I wonder he read which book?*

Furthermore, the AC immediately predicts classic superiority effects of the following kind:

- (10) a. Who read what?
 b. *What did who read?

To see that this is so, consider the following derivation:

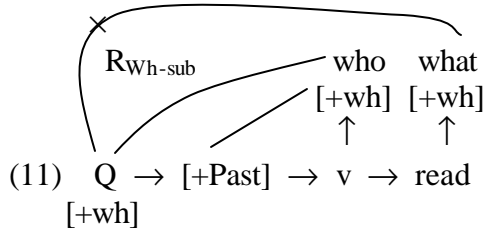

By the time $Q[+wh]$ is introduced into the derivation, *what* has already been rendered inaccessible by the presence of a new LI *who* with a $[+wh]$ feature. Hence *who* may be subcategorized by $Q[+wh]$, but *what* may not.

Interesting complications arise when one or more of the *wh*-words appear in positions other than subject or object position. The AC, as stated in the previous chapter, refers only to subcategorized phrases. Hence it does not predict strong superiority effects in cases where one or both of the *wh*-phrases are in non-argument positions. For quite a wide range of data this prediction seems correct:⁴⁶

⁴⁶ Further complications arise from Pesetsky's (1987) observation that so-called "D-linked" *wh*-phrases can be fronted more easily than non-D-linked ones. Compare (10) with the following pair, where the contrast is not nearly so clear:

- (i) a. Which students bought which books?

- (12) a. Which students ran how fast?
b. How fast did which students run?
- (13) a. What did you give to whom?
b. To whom did you give what?
- (14) a. How did he fix what?
b. What did he fix how?
- (15) a. When did they arrest who?
b. Who did they arrest when?
- (16) a. At which locations were how many students arrested?
b. How many students were arrested at which locations?
- (17) a. Who took the test at what time?
b. (?)At what time did who take the test?
- (18) a. Who bought what when?
b. When did who buy what?

b. (?)Which books did which students buy?

Though there does seem to be a mild but reliable superiority effect when any *wh*-phrase is moved over a non-D-linked subject, even this effect can be overridden in a variety of contexts, as shown, for example, in (18). Given the uncertainty of the data and the wide range of semantic and contextual factors involved, I will not pursue this topic further here, assuming that the clear core cases of superiority can be accounted for by the AC.

Returning briefly to the topic of auxiliary inversion, consider the form of *wh*-questions where the verb is a simple present or past tense form and the subject contains the *wh*-word:

(19) a. Who bought the book?

b. *Who did buy the book?

Questions of this type raise several questions for the standard theory of movement. First, should “vacuous” movement of the subject *wh*-word should be permitted in principle? Second, if vacuous movement is allowed, why does the auxiliary *do* not appear? Third, is there a principled basis for preventing vacuous movement, and if so, how is the question interpretation to be derived from a structure identical to that of corresponding declarative sentence *he bought the book*?

None of these problems arise in the theory proposed here. To see that this is so, consider the following derivation:

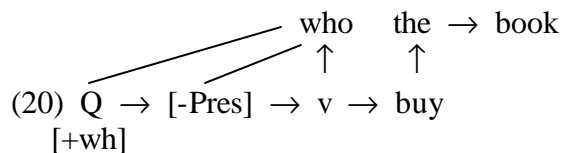

Let us assume the null hypothesis, namely, that Q forms a *wh*-subcategorization relation with *who* and that a copy of the feature [-Pres] is substituted for Q at PHON. Then an occurrence of the phonetic form of *who* must precede [-Pres], resulting in the phonetic form: who-[-Pres]-<who>-<[-Pres]>-<who>-buy-the-book-<buy>. But notice that [-Pres] is adjacent to buy in this structure. Hence there is nothing to prevent the morphophonemic rules from converting the substring [-Pres]-buy into the phonetically readable form bought. It is only when the tense feature is separated from the phonetic form of the verb at PHON that do must be inserted to prevent the derivation from crashing.

3 Wh-agreement

We have seen in previous chapters that LIs of category D are not only subcategorized, but also have ϕ -features that must form an agreement relation with an LI containing matching ϕ -features. I show in this section that there is a kind of agreement relation that holds between the *wh*-feature in C and one or more LIs containing matching *wh*-features. To be more specific, the [+wh] feature in C must form a relation of *wh-agreement* with one or more phrases containing a [+wh]-feature. However, in order to show that *wh*-agreement is needed in addition to *wh*-subcategorization, it is necessary to go beyond single clauses and look at data from complex sentences.

Let us start by considering the following well-known contrast:

(21) a. Why do you think that he stole it?

b. Why do you wonder who stole it?

In (21a), *why* can be understood to be associated with the embedded clause, whereas in (21b) such an interpretation is impossible. Now consider the derivation of (21b):

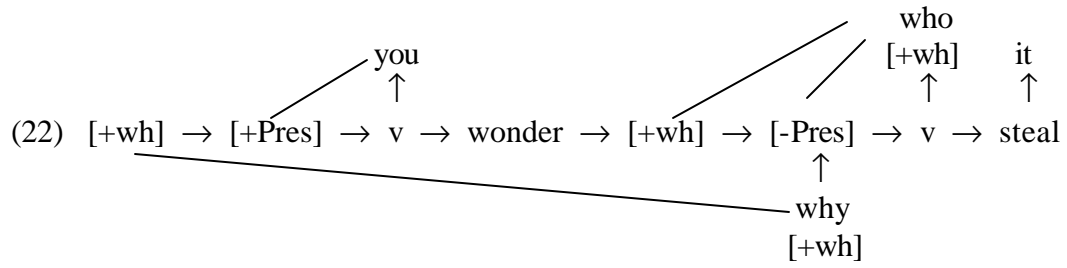

The problem is this: what prevents $[+wh]$ in the matrix clause from forming a *wh*-subcategorization relation with *why*? We saw in the previous section that movement of a *wh*-adjunct over another *wh*-phrase produces at worst a mild superiority violation. But in (21b) the *wh*-adjunct simply cannot be construed as originating in the lower clause, a much stronger effect than expected.

Collins and Ura (2001) suggest that there is an agreement relation between the matrix $[+wh]$ and *why* and that this relation is disrupted by the $[+wh]$ feature in C of the embedded clause. Some support for this view is provided by examples such as the following in which extraction of *why* appears to be degraded when there is only a $[+wh]$ feature in C in the embedded clause:

(23) ??Why do you wonder whether/if he stole the money?

However, the violation in (23) doesn't seem as clear-cut as the one in (21b).⁴⁷ Even more problematic is the fact that extraction of arguments from such complements, as is well known, produces only the very mildest of violations:

(24) (?)What do you wonder if/whether he stole?

leading one to wonder whether the strong island violation of (21b) could really be entirely due to the intervening [+wh] feature in C.

A more plausible hypothesis is the following. Let us suppose that the [+wh] feature in C must form a wh-agreement relation with any and all [+wh]-marked LIs that have not already formed a relation with some other [+wh] feature. Let us suppose in addition that wh-agreement, like ϕ -agreement, is subject to the Inertness Condition (IC). It follows, then, that as soon as the [+wh] feature of a LI has formed a wh-relation with a [+wh] feature in C, it becomes inaccessible to any further wh-agreement relations. This immediately provides an explanation for the contrast in (21). In (21a) *why* in the embedded clause is free to form a wh-agreement relation with the [+wh] in C in the matrix clause because there is no [+wh] in C of the embedded clause with which it could have formed one first. In (21b), in contrast, [+wh] in the embedded C must, by hypothesis, form wh-agreement relations with both *why* and *who*. Thus by the time we

⁴⁷ One might wonder whether (23) is in fact syntactically ill-formed. Perhaps it is simply semantically or pragmatically anomalous on the intended reading, since it would seem to be somewhat premature to wonder *why* he stole the money while still in the process of wondering whether he did it at all. Notice the semantic anomaly of the echo question #*You wonder whether/if he stole the money why?*, contrasting with *You wonder whether/if he stole the money from whom?*

get to [+wh] in the matrix clause, both LIs have already formed an agreement relation with another [+wh], hence are no longer accessible by the IC. Schematically, the two situations are as follows:

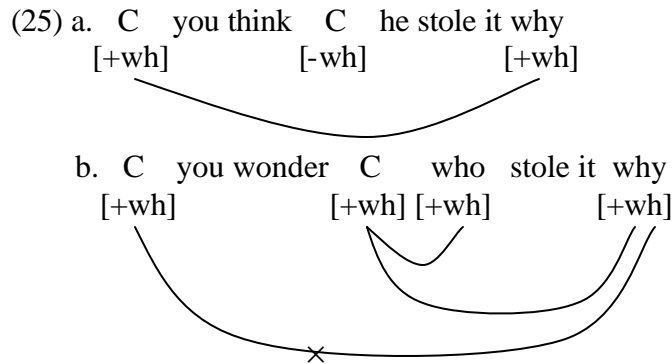

This account carries over to the Japanese example cited by Collins and Ura, as well:

- (26) Kimi-wa [John-ga naze katta ka] sitte-imasu ka?
 you-Top Nom why won C[+wh] know-Polite C[+wh]
 ‘Do you know why John won?’

The observation is that the *wh*-adjunct *naze* ‘why’ cannot be construed with the matrix *ka*. The explanation is straightforward: *naze* must form a *wh*-agreement relation with *ka* in the embedded clause. Hence when matrix *ka* is introduced into the derivation, *naze* is no longer accessible.

Given a theory of this sort, it now becomes clear why WH-Island violations are more robust than superiority violations. Superiority effects, which involve *wh*-subcategorization, are brought about by violations of the AC and only affect linear ordering at PHON. WH-Island effects, which involve *wh*-agreement (in some cases, *wh*-

subcategorization as well) are brought about by violations of the IC and, as will be shown in the next section, affect interpretation at SEM. Notice, for example, how the following examples become increasingly degraded:

- (27) a. What do you think who bought? (wh-subcategorization only)
- b. When do you wonder who stole the book? (wh-agreement only)
- c. What do you wonder who stole? (wh-subcategorization and wh-agreement)

(27a) is a superiority violation exactly like (10b), except that an occurrence of the phonetic form of *what* precedes C in the matrix clause instead of C in the embedded clause. Though degraded, it is still comprehensible. (27b), a robust WH-Island effect, as was shown above, is ill-formed at SEM on the intended reading. Finally, (27c), which contains both a superiority violation and a WH-Island violation, is ill-formed at both PHON and SEM .

It was shown in the preceding chapter that ϕ -agreement is regulated by both the AC and the IC. Wh-agreement, in contrast, is governed only by IC. Why should this be so? The immediate explanation is that a wh-probe, unlike a ϕ -probe, must form relations with all accessible LIs with matching features. Hence the AC will simply never be applicable, whereas the IC will. This in turn leads one to ask why wh-agreement behaves

as variable binding: $F_I[R_{wh-agr}(C[+wh], X[+wh])] = Q'_x[\dots x \dots]$. Given these assumptions, an interpretation of the following form will automatically be assigned to (28):

(29) $Q'_x[\text{Past}'(v'(\text{buy}'(\text{THING}'(x))))(\text{he}')]]$

Consider next a sentence such as *who bought what?*, containing two *wh*-phrases. The interpretation is roughly as follows: 'For what x , x a non-animate entity, and for what y , y an animate entity, is it the case that y bought x ?' This suggests that there must be two variables in the semantic representation in this case, bound by a two-place interrogative operator $Q'_{x,y}$. It was proposed in the preceding section that the $[+wh]$ feature in C must form a *wh*-agreement relation with any *wh*-phrases that are accessible. Since there are two accessible *wh*-phrases in this case, the ternary relation $R_{wh-agr}(C[+wh], X[+wh], Y[+wh])$ is formed, to which F_I applies, producing an interpretation of the following form:

(30) $Q'_{x,y}[\text{Past}'(v'(\text{buy}'(\text{THING}'(y))))(\text{PERSON}'(x))]]$

This procedure can easily be generalized, so that an n -ary *wh*-agreement relation in the syntax will be interpreted in SEM as an expression containing $n-1$ variables bound by an $n-1$ place interrogative operator.

Recall now that the search space of FormRel for the *wh*-agreement relation is governed by the IC, which renders a *wh*-phrase inaccessible to another *wh*-agreement relation as soon as its $[+wh]$ -feature has been checked. It follows immediately from the

legibility conditions proposed above that as soon as a variable is bound by an operator, it is no longer available to be bound by another operator. This in turn explains why (21b) has no interpretation in which the translation of *why* is bound by an operator in the matrix clause. A derivation of the form schematized in (25b) is ruled out by the IC and the corresponding interpretation at SEM, in which the variable contained in the interpretation of *why* is bound by both the operator in the embedded clause and the operator in the matrix clause, is ruled out at the same time. If, on the other hand, *why* is a modifier in the matrix clause, then it will form a wh-agreement relation only with the [+wh]-feature in the matrix C. Hence it will have a valid interpretation also, in which the variable corresponding to *why* is bound by only a single operator.

Similarly, consider the sentence *who bought what*, whose interpretation is shown in (30). Suppose it is selected as a complement by a verb such as *wonder*. Then by the IC neither *who* nor *what* is accessible to the [+wh] feature of C in the matrix clause. Hence both *Who do you wonder bought what?* and *What do you wonder who bought?* are syntactically ill-formed and semantically uninterpretable.

If this approach is correct, then the differences between ϕ -agreement and wh-agreement arise from the fact that syntactic relations of the latter kind mediate between operator-variable structures at SEM and morphological agreement properties at PHON, whereas relations of the former kind have a completely different function. Purely computational constraints such as the IC, however, apply indiscriminately to the formation of agreement relation of both kinds, regardless of function.

References

- Abney, Steven. 1987. The English noun phrase in its sentential aspect. Doctoral dissertation, MIT.
- Babby, Leonard. 1975. A transformational analysis of transitive –SJA verbs in Russian. *Lingua*.
- Babby, Leonard. 1989. Subjectlessness, external subcategorization, and the Projection Principle. *Zbornik Matice srpske za filologiju i lingvistiku* 9:1-55.
- Babby, Leonard. 1994. A theta-theoretic analysis of adversity impersonal sentences in Russian. In *FASL 2: The MIT Meeting*, ed. Sergey Avrutin, Steven Franks, and Ljiljana Progovac, 25-67. Ann Arbor: Michigan Slavic Publications.
- Bach, Emmon. 1988. Categorical grammars as theories of language. In *Categorical grammars and natural language structures*, eds. Richard Oehrle, Emmon Bach, and Deirdre Wheeler, 17-34. Dordrecht: Reidel.
- Bowers, John. 1973[1986]. Grammatical relations. Doctoral dissertation, MIT, Cambridge, Mass. [Published by Garland, New York, 1986.]
- Bowers, John. 1979. On negative transportation. In *Contributions to grammatical studies: semantics and syntax*, eds. Linda R. Waugh and Frans van Coetsem, 42-69. Leiden: E.J. Brill.
- Bowers, John. 1981. *The theory of grammatical relations*. Ithaca, NY: Cornell University

- Press.
- Bowers, John. 1993. The syntax of predication. *Linguistic Inquiry* 24.4:591-656.
- Bowers, John. 1997. A binary analysis of resultatives. In *Texas linguistic forum 38: The syntax and semantics of predication*, ed. Ralph C. Blight and Michelle J. Moosally, 43-58. Department of Linguistics, The University of Texas at Austin.
- Bowers, John. 1999. Predication and argument structure. Invited talk, Princeton University, Princeton, NJ.
- Bowers, John. 2000. Syntactic relations. Ms., Cornell University, Ithaca, N.Y.
- Bowers, John. 2001a. Predication. In *The handbook of contemporary syntactic theory*, ed. Mark Baltin and Chris Collins, 299-333. Blackwell, Oxford.
- Bowers, John. 2001b. On reducing obligatory control to movement. Ms., Cornell University, Ithaca, NY.
- Bowers, John. 2002. Transitivity. *Linguistic Inquiry* 33.2: 183-224.
- Bowers, John and Uwe K.H. Reichenbach. 1979. Montague Grammar and transformational grammar: A review of *Formal philosophy: Selected papers of Richard Montague*. *Linguistic Analysis* 5: 195-246.
- Bresnan, Joan. 1971. Sentence stress and syntactic transformations. *Language* 47:257-281.
- Chierchia, Gennaro. 1984. Topics in the syntax of infinitives and gerunds. Doctoral dissertation, University of Massachusetts, Amherst.

- Chierchia, Gennaro. 1985. Formal semantics and the grammar of predication. *Linguistic Inquiry* 16: 417-443.
- Chierchia, Gennaro. 1989. A semantics for unaccusatives and its syntactic consequences. Ms., Cornell University, Ithaca, NY.
- Chomsky, Noam. 1955. *The logical structure of linguistic theory*. Chicago: University of Chicago Press (1975).
- Chomsky, Noam. 1957. *Syntactic structures*. The Hague: Mouton.
- Chomsky, Noam. 1981. *Lectures on government and binding*. Dordrecht: Foris.
- Chomsky, Noam. 1995. *The minimalist program*. Cambridge, Mass.: MIT Press.
- Chomsky, Noam. 2000. Minimalist inquiries. In *Step by step: Essays on minimalist syntax in honor of Howard Lasnik*, eds. Roger Martin, David Michaels and Juan Uriagereka, 89-155. Cambridge, Mass.: MIT Press.
- Chomsky, Noam. 2001a. Derivation by phase. In *Ken Hale: A life in language*, ed. Michael Kenstowicz, 1-52. Cambridge, Mass.: MIT Press.
- Chomsky, Noam. 2001b. Beyond explanatory adequacy. In *MIT Occasional Papers in Linguistics* 20, . MITWPL, Department of Linguistics and Philosophy, MIT, Cambridge, Mass.
- Cinque, Guglielmo. 1990. Ergative adjectives and the lexicalist hypothesis. *Natural Language and Linguistic Theory* 8: 1-39.
- Collins, Chris. 1997. *Local economy*. Cambridge, Mass.: MIT Press.
- Collins, Chris. 2003. Eliminating labels. In *Derivation and explanation in the minimalist program*, eds. Samuel David Epstein and T. Daniel Seely, 42-61. Oxford:

Blackwell.

Collins, Chris. To appear. The internal structure of vP in Ju 'hoan and Hoan. *Studia Linguistica* 57.1.

Collins, Chris and Hiroyuki Ura. 2001. Eliminating phrase structure. Ms., Cornell University and Kwansai Gakuin University.

Dobashi, Yoshihito. 2003. Phonological phrasing and syntactic derivation. Doctoral dissertation, Cornell University.

Dowty, David. 1978. Governed transformations as lexical rules in a Montague Grammar. *Linguistic Inquiry* 9: 393-426.

Epée, Roger. 1976. Generative syntactic studies in Duala. Doctoral dissertation, Cornell University.

Epstein, Samuel D., Erich M. Groat, Ruriko Kawashima and Hisatsugu Kitahara. 1998. *A derivational approach to syntactic relations*. Oxford: Oxford University Press.

Hornstein, Norbert. 1999. Movement and control. *Linguistic Inquiry* 30:69-96.

Hornstein, Norbert. 2001. *Move! A minimalist theory of construal*. Oxford: Blackwell.

Katz, Jerrold J. and Jerry A. Fodor. 1963. The structure of a semantic theory. *Language* 39: 170-210.

Katz, Jerrold J. and Paul M. Postal. 1964. *An integrated theory of linguistic descriptions*. Cambridge, Mass.: MIT Press.

Kayne, Richard S. 1994. *The antisymmetry of syntax*. Cambridge, Mass.: MIT Press

Keyser, Samuel Jay and Thomas Roeper. 1984. On the middle and ergative constructions in English. *Linguistic Inquiry* 15:381-416.

- Kiparsky, Paul and Carol Kiparsky. 1971. Fact. In *Semantics: An interdisciplinary reader in philosophy, linguistics and psychology*, eds. Danny D. Steinberg and Leon A. Jakobovits, 345-369. Cambridge University Press.
- Klein, Ewan and Ivan Sag. 1985. Type driven translation. *Linguistics and Philosophy* 8: 163-202.
- Koizumi, Masatoshi. 1993. Object agreement phrases and the split VP hypothesis. In *MIT working papers in linguistics 18*, 99-148. MITWPL, Department of Linguistics and Philosophy, MIT, Cambridge, Mass.
- Koizumi, Masatoshi. 1995. Phrase structure in minimalist syntax. Doctoral dissertation, MIT, Cambridge, Mass.
- Kratzer, Angelika. 1993. On external arguments. *University of Massachusetts Occasional Papers 17*. University of Massachusetts, Amherst, Mass.
- Kuroda, S.-Y. 1972. The categorial and thetic judgement (evidence from Japanese syntax). *Foundations of Language* 2: 153-185.
- Lavine, J. 2000. Topics in the syntax of nonagreeing predicates in Slavic. Doctoral dissertation, Princeton University, Princeton, N.J.
- Levin, Beth and Malka Rappaport Hovav. 1995. *Unaccusativity: At the syntax-semantics lexical interface*. Cambridge, Mass.: MIT Press.
- Moore, John and David Perlmutter. 2001. Evidence for silent expletives in Russian. Paper read at the 75th Annual Meeting of the Linguistic Society of America.
- Perlmutter, David and John Moore. 2001. Language-internal explanation: the distribution of Russian impersonals. Unpublished paper.

- Perlmutter, David. 2001. Language-internal and cross-linguistic bases of explanation. Presidential Address, 75th Annual Meeting of the Linguistic Society of America.
- Pesetsky, David. 1987. *Wh-in-situ: Movement and unselective binding*. In *The representation of (in)definiteness*, eds. Eric Reuland and Alice ter Meulen, 98-129. Cambridge, Mass.: MIT Press.
- Pollard, Carl. 1984. Head grammars, generalized phrase structure grammars, and natural language. Doctoral dissertation, Stanford University, Stanford, California.
- Ramchand, Gillian. 1997. *Aspect and predication: The semantics of argument structure*. Oxford University Press.
- Rosenbaum, Peter. 1967. *The grammar of English predicate complement constructions*. Cambridge, Mass.: MIT Press.
- Rothstein, Susan. 1983. The syntactic form of predication. Doctoral dissertation, MIT, Cambridge, Mass.
- Rothstein, Susan. 2001. *Predicates and their subjects*. Dordrecht; Boston: Kluwer.
- Sobin, N. 1985. Case assignment in Ukrainian morphological passive constructions. *Linguistic Inquiry* 16:649-662.
- Ura, Hiroyuki. 1999. *Checking theory and grammatical functions in universal grammar*. New York: Oxford University Press.
- Wall, Robert. 1972. *Introduction to mathematical linguistics*. Englewood Cliffs, NJ: Prentice-Hall, Inc.

